



# AESCULAP® Power Systems

Catalog 2024

ELAN 4 and Acculan 4



# Content

---

## ELAN 4

- › ELAN 4 electro
  - › ELAN 4 Accessories
- 

## Acculan 4

- › Acculan 4
  - › Acculan 4 Small Drill
  - › Acculan 4 Electro
  - › Acculan 4 Accessories
- 

## Processing

- › Sterilit® Power Systems
  - › Processing
- 

## Others

- › Tool Attachments Overview
  - › Signs & Symbols
  - › Brochures
  - › Index
-





# AESCLAP<sup>®</sup> ELAN 4

Precision. Performance. Pleasure.

With its technical concept ELAN 4 addresses important requirements of the surgeon and all parties involved in handling power systems in the hospital.

- Convenient and reliable grip
- Powerful, precise and reliable work
- Easy to set up and simple to use



# AESCLAP® ELAN 4

ELAN 4 electro

Electric Highspeed System



# ELAN 4 electro

## Basic components

### GA800

#### ELAN 4 electro control unit

with irrigation pump; touch screen;

pump flow 0–65 ml/min

100–240 V AC; 50/60 Hz;

380 x 330 x 200 mm; 9,500 g

consisting parts:

GD412804 bottle holder

power cord not included

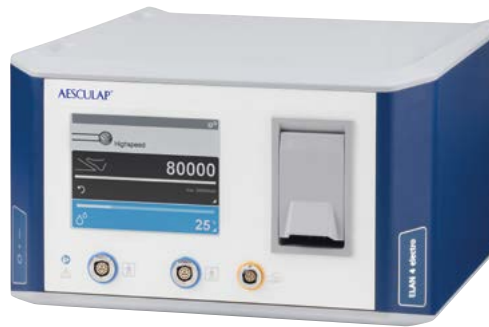

### GA808

#### ELAN 4 electro foot control

protection type IPX8; anaesthetic proof class AP

5.0 m;

245 x 144 x 76 mm; 2,240 g

consisting parts:

GA808207 rail



### GA810

#### ELAN 4 electro wireless foot control

protection type IPX8; anaesthetic proof class AP

271 x 266 x 85 mm; 3,800 g

Requires control unit with software version V3.00.

consisting parts:

GA810202 rail

3 batteries Type D/LR20/Mono



### GA806

GB073R

#### ELAN 4 electro motor cable

for use with ELAN 4 electro applied parts

4.0 m; 270 g

consisting parts:

GB600860 Sterilit® spray adapter

ELAN 4 electro



# AESCULAP® ELAN 4

## ELAN 4 electro

Basic components, perforator driver & lowspeed motor

**GA804**

**GB073R**

### ELAN 4 electro motor cable with hand switch

for use with ELAN 4 electro applied parts

4.0 m; 374 g

consisting parts:  
GB600860 Sterilit® spray adapter  
ELAN 4 electro



**GA805**

**GB073R**

### ELAN 4 electro motor cable with hand control

for use with ELAN 4 electro applied parts

4.0 m; 369 g

consisting parts:  
GB600860 Sterilit® spray adapter  
ELAN 4 electro



**GA822**

**GB076R**

### ELAN 4 electro perforator driver

for use with cranial perforators with Hudson shank

180 W; 0 - 1,200 rpm; 250 Ncm;  
166 x 35 mm; 410 g



**GA824**

**GB077R**

### ELAN 4 electro lowspeed motor with intra coupling

180 W; 0 - 40,000\* rpm;  
10 Ncm; 123 x 23 mm; 150 g

\* Requires control unit with software version V3.00. With lower versions the motor runs max. 20,000 rpm.



# ELAN 4 electro

## Craniotome & attachments

**GA849**

**GB085R**

### ELAN 4 electro craniotome and multifunction handpiece

2-ring coding; for use with dura guards and holding sleeves GB941R - GB947R; spray nozzle GA259SU (not included)

140 W; ↻ ↺; 0 - 80,000 rpm; 2.2 Ncm; 156 x 17 mm; 📖 121 g



**GB941R**

**GB719R**

### ELAN 4 dura guard pediatric

fixed; 1 dot coding; for craniotome and multifunction handpieces GA749, GA849



**GB942R**

**GB719R**

### ELAN 4 dura guard standard

fixed; 2 dot coding; for craniotome and multifunction handpieces GA749, GA849



**GB943R**

**GB719R**

### ELAN 4 dura guard long

fixed; 3 dot coding; for craniotome and multifunction handpieces GA749, GA849



**GB945R**

**GB719R**

### ELAN 4 holding sleeve

for craniotome and multifunction handpieces GA749, GA849



**GB947R**

**GB719R**

### ELAN 4 dura guard standard

turnable; 2 dot coding; for craniotome and multifunction handpieces GA749, GA849



# AESCULAP® ELAN 4

## ELAN 4 electro

### 1-ring highspeed handpieces

**GA861**

**GB083R**

#### ELAN 4 electro 1-ring handpiece L4

1-ring coding;  
spray nozzle GA261SU (not included)  
140 W; ↗ ↘; 0 - 80,000 rpm; 2.2 Ncm;  
152 x 16 mm; 80 g



**GA862**

**GB083R**

#### ELAN 4 electro 1-ring handpiece L7

1-ring coding;  
spray nozzle GA262SU (not included)  
140 W; ↗ ↘; 0 - 80,000 rpm; 2.2 Ncm;  
177 x 16 mm; 83 g



**GA863**

**GB083R**

#### ELAN 4 electro 1-ring handpiece L10

1-ring coding;  
spray nozzle GA263SU (not included)  
140 W; ↗ ↘; 0 - 80,000 rpm; 2.2 Ncm;  
206 x 16 mm; 87 g

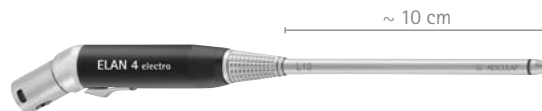

**GA864**

**GB083R**

#### ELAN 4 electro 1-ring handpiece L13

1-ring coding;  
spray nozzle GA264SU (not included)  
140 W; ↗ ↘; 0 - 80,000 rpm; 2.2 Ncm;  
237 x 16 mm; 91 g

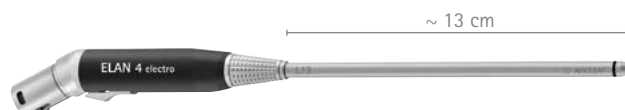

# ELAN 4 electro

## 2-ring highspeed handpieces

**GA865**

**GB083R**

### ELAN 4 electro 2-ring handpiece L7

2-ring coding;  
spray nozzle GA265SU (not included)  
140 W; ↗ ↘; 0-80,000 rpm; 2.2 Ncm;  
176 x 16 mm; 📖 89 g



**GA866**

**GB083R**

### ELAN 4 electro 2-ring handpiece L10

2-ring coding;  
spray nozzle GA266SU (not included)  
140 W; ↗ ↘; 0-80,000 rpm; 2.2 Ncm;  
206 x 16 mm; 📖 95 g



**GA867**

**GB083R**

### ELAN 4 electro 2-ring handpiece L13

2-ring coding;  
spray nozzle GA267SU (not included)  
140 W; ↗ ↘; 0-80,000 rpm; 2.2 Ncm;  
236 x 16 mm; 📖 100 g

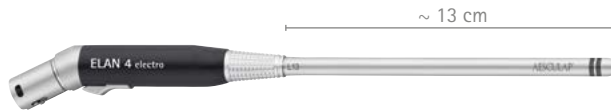

**GA868**

**GB083R**

### ELAN 4 electro 2-ring handpiece L17

2-ring coding;  
spray nozzle GA268SU (not included)  
140 W; ↗ ↘; 0-80,000 rpm; 2.2 Ncm;  
276 x 16 mm; 📖 108 g



**GA869**

**GB083R**

### ELAN 4 electro 2-ring handpiece L22

2-ring coding;  
spray nozzle GA269SU (not included)  
140 W; ↗ ↘; 0-80,000 rpm; 2.2 Ncm;  
326 x 16 mm; 📖 118 g



# AESCULAP® ELAN 4

ELAN 4 electro

MIS handpiece & handpiece shafts





**GA860**

**GB084R**

**ELAN 4 electro MIS handpiece**

for use with MIS handpiece shafts  
GB920R - GB927R

140 W; ↻ ↺; 0 - 80,000 rpm;  
2.2 Ncm; 118 x 17 mm; ⚖ 100 g

consisting parts:

GB600870 Sterilit® spray adapter for  
ELAN 4 MIS handpiece shafts



**GB920R**

**GB723R**

**ELAN 4 MIS handpiece shaft  
L10 straight**

spray nozzle GB796SU (not included)



**GB921R**

**GB723R**

**ELAN 4 MIS handpiece shaft  
L10 curved**

spray nozzle GB796SU (not included)



**GB922R**

**GB723R**

**ELAN 4 MIS handpiece shaft  
L10 heavy curved**

spray nozzle GB796SU (not included)



**GB925R**

**GB723R**

**ELAN 4 MIS handpiece shaft  
L13 straight**

spray nozzle GB797SU (not included)



**GB926R**

**GB723R**

**ELAN 4 MIS handpiece shaft  
L13 curved**

spray nozzle GB797SU (not included)



**GB927R**

**GB723R**

**ELAN 4 MIS handpiece shaft  
L13 heavy curved**

spray nozzle GB797SU (not included)



# AESCLAP® ELAN 4

ELAN 4 electro  
Saws



**GA836**

**GB086R**

**ELAN 4 electro micro sagittal saw**

spray nozzle GA258SU (not included)  
180 W; 0 - 20,000 rpm; 161 x 23 mm;  
 $\sphericalangle$  7°;  $\updownarrow$  190 g



**GA837**

**GB087R**

**ELAN 4 electro micro reciprocating saw**

spray nozzle GA258SU (not included)  
180 W; 0 - 20,000 rpm; 184 x 23 mm;  
 $\updownarrow$  1.3 mm;  $\updownarrow$  198 g



**GA831**

**GB088R**

**ELAN 4 electro sagittal saw**

spray nozzle GA258SU (not included)  
180 W; 0 - 20,000 rpm; 129 x 23 mm;  
 $\sphericalangle$  4.5°;  $\updownarrow$  220 g



**GA832**

**GB087R**

**ELAN 4 electro reciprocating saw**

spray nozzle GA258SU (not included)  
180 W; 0 - 20,000 rpm; 194 x 23 mm;  
 $\updownarrow$  2.5 mm;  $\updownarrow$  238 g



**GA833**

**GB088R**

**ELAN 4 electro transversal saw**

spray nozzle GA258SU (not included)  
180 W;  $\sphericalangle$   $\sphericalangle$ ; 0 - 20,000 rpm; 10 Ncm;  
130 x 23 mm;  $\sphericalangle$  10°;  $\updownarrow$  185 g  
to be used with saw blade shafts  
GP580R, GP582R, GP586R and GP590R

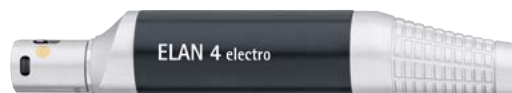

# AESCULAP® ELAN 4

ELAN 4 electro  
Drill





**GA844**

**GB482R**

**ELAN 4 electro drill**

with fixed motor cable, oscillating and tapping mode

200 W;  3.2 mm;  
122 x 130 x 27 mm;  800 g

consisting parts:

GA344244 K-wire protection guide

TA011944 cleaning brush

GA344211 rinsing adapter

GB600880 Sterilit® spray adapter

Requires control unit with software version V3.00.





**GB870R**

**GB716R**

**Intramedullary reamer attachment**

with Jacobs chuck 0.5 - 7.4 mm,  
not for use with acetabulum reamers

0 - 320 rpm; 6.5 Nm;  3.2 mm;  
105 x 29 mm;  230 g

consisting parts:

key GA031R





**GB871R**

**GB716R**

**Intramedullary reamer attachment**

with large AO chuck,  
not for use with acetabulum reamers

0 - 320 rpm; 6.5 Nm;  3.2 mm;  
88 x 29 mm;  170 g





**GB872R**

**GB716R**

**Intramedullary reamer attachment**

with Hudson/Zimmer chuck,  
not for use with acetabulum reamers

0 - 320 rpm; 6.5 Nm;  3.2 mm;  
86 x 25 mm;  150 g



# AESFULAP® ELAN 4

## ELAN 4 electro Attachments

**GB881R**

**GB716R**

**Drill attachment**

with Jacobs chuck 0.5 - 7.4 mm

0 - 1,250 rpm; 2 Nm;  3.2 mm;  
89 x 29 mm;  163 g

consisting parts:  
key GA031R





**GB882R**

**GB716R**

**Drill attachment**

with Jacobs chuck 0.5 - 4 mm

0 - 1,250 rpm; 2 Nm;  3.2 mm;  
76 x 22 mm;  100 g

consisting parts:  
key GA062R





**GB884R**

**GB716R**

**Drill attachment**

with small AO chuck

0 - 1,250 rpm; 2 Nm;  2.8 mm;  
60 x 22 mm;  66 g





**GB886R**

**GB716R**

**Drill attachment**

with AESFULAP® hexagonal chuck

0 - 1,250 rpm; 2 Nm;  3.2 mm;  
57 x 24 mm;  67 g





**GB887R**

**GB716R**

**Drill attachment**

with Dental shank

0 - 1,250 rpm; 2 Nm;  1.8 mm;  
56 x 22 mm;  50 g



**GB878R**

**GB716R**

**Drill attachment**

for Synthes radiolucent drive 511.300

0 - 1,250 rpm; 2 Nm;  
111 x 27 mm; 181 g



**GB894R**

**GB716R**

**K-wire attachment**

for K-wires from 0.6 - 3.2 mm

0 - 1,250 rpm; 3.2 mm;  
92 x 27 x 124 mm; 179 g



**GB891R**

**GB716R**

**Sagittal saw attachment**

for "L-sagittal" sawblades

0 - 15,750 rpm; 74 x 33.5 mm;  
4.5°; 179 g



**GB892R**

**GB716R**

**Reciprocating saw attachment**

for reciprocating sawblades

0 - 15,750 rpm; 135 x 24.5 mm;  
2.5 mm; 166 g



# AESCULAP® ELAN 4



## ELAN 4 electro Attachments

**GB896R**

**GB716R**

### Screw attachment

with small AO chuck

0 - 165 rpm; 12 Nm;  1.7 mm;  
95 x 28 x 129.5 mm;  235 g





**GB897R**

**GB716R**

### Screw attachment

with AESCULAP® hexagonal chuck

0 - 165 rpm; 12 Nm;  1.7 mm;  
92 x 28 x 129.5 mm;  231 g





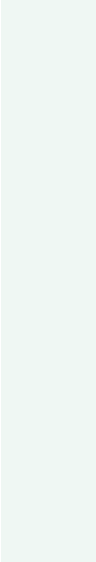

# AESCU LAP<sup>®</sup> ELAN 4

## ELAN 4 accessories

**GB861P**

**GB727R**

**ELAN 4 length reduction sleeve**  
for use with 1-ring handpieces



**GB863P**

**GB727R**

**ELAN 4 length reduction sleeve**  
for use with 2-ring handpieces



**GB862P**

**GB727R**

**ELAN 4 MIS sleeve**  
for use with 1-ring handpieces



**GB866R**

**ELAN 4 lateral burr guard**  
for use with 1-ring handpieces and  
burrs up to 4.5 mm diameter



**TE780**

**Power cord**  
Europe, 1.5 m

**TE730**

**Power cord**  
Europe, 5.0 m

**TE734**

**Power cord**  
UK, 5.0 m

**TE735**

**Power cord**  
USA, Canada, Japan, 3.5 m



**GA395SU**

sterile  

ELAN 4 electro disposable tube set



## ELAN 4 SPRAY NOZZELS

sterile 

**GA259SU**

for craniotome attachments

**GA261SU**

for 1-ring handpiece L4

**GA262SU**

for 1-ring handpiece L7

**GA263SU**

for 1-ring handpiece L10

**GA264SU**

for 1-ring handpiece L13

**GA265SU**

for 2-ring handpiece L7

**GA266SU**

for 2-ring handpiece L10

**GA267SU**

for 2-ring handpiece L13

**GA268SU**

for 2-ring handpiece L17

**GA269SU**

for 2-ring handpiece L22

**GB796SU**

for MIS handpiece shafts L10

**GB797SU**

for MIS handpiece shafts L13



**GA258SU**

for saws





# AESCULAP® Acculan 4

Look. Feel. Experience.

Acculan 4 the battery-operated power system for orthopaedics, traumatology, cardiothoracic surgery and dermatology

- Powerful
- Longevity – Exclusion of battery and electronic control from sterilization process
- Easy handling – Titanium housing allows mechanical alkaline reprocessing



# AESCULAP® Acculan 4

## Drill & attachments

**GA330**

**GB495R**

### Acculan 4 drill and reamer

250 W;  4.0 mm;  
207 x 121 x 55 mm;  1,250 g

consisting parts:

GA678 sterile funnel

GA672207 K-wire protection sleeve

TA011944 cleaning brush

GA672211 rinsing adapter

GB600840 Sterilit® spray adapter

Acculan

Lid GA675 and NiMH battery GA676 to be ordered separately.

Measurements and weight are including battery and lid.





**GB620R**

**GB496R**

### Acculan 4 drill attachment

with Jacobs chuck 0.5 - 7.4 mm

0 - 1,000 rpm; 5.0 Nm;  4.0 mm;  
133 x 35 mm;  397 g

consisting parts:

key GA031R





**GB621R**

**GB496R**

### Acculan 4 drill attachment

with Jacobs chuck 0.5 - 7.4 mm

0 - 1,000 rpm; 5.0 Nm;  4.0 mm;  
118 x 35 mm;  300 g

consisting parts:

key GA031R





**GB623R**

**GB496R**

### Acculan 4 drill attachment

with small AO chuck

0 - 1,250 rpm; 4.0 Nm;  2.8 mm;  
90 x 35 mm;  210 g





# Attachments

**GB639R**

**GB496R**

## Acculan 4 drill attachment

with Jacobs chuck 0.5 – 4.0 mm

0 – 1,250 rpm; 4.0 Nm;  4.0 mm;  
105 x 35 mm;  243 g

consisting parts:  
key GA062R



**GB645R**

**GB496R**

## Acculan drill attachment

for Synthes radiolucent drive 511.300

0 – 900 rpm; 110 x 35 mm;  225 g





**GB663R**

**GB496R**

## Acculan 4 drill attachment

with trinkle chuck

0 – 1,000 rpm; 5.0 Nm;  4.0 mm;  
93 x 35 mm;  217 g





**GB664R**

**GB496R**

## Acculan 4 drill attachment

with AESCULAP® hexagonal chuck

0 – 1,000 rpm; 5.0 Nm;  4.0 mm;  
86 x 35 mm;  225 g





**GB665R**

**GB496R**

## Acculan 4 drill attachment

with Hudson / Zimmer chuck

0 – 1,000 rpm; 5.0 Nm;  4.0 mm;  
100 x 35 mm;  230 g



# AESCULAP® Acculan 4



## Attachments

**GB657R**

**GB496R**

### Acculan 4 intramedullar attachment

with large AO chuck

0 - 370 rpm; 12.0 Nm;  4.0 mm;  
108 x 35 mm;  300 g





**GB667R**

**GB496R**

### Acculan 4 reamer attachment

with Jacobs chuck 0.5 - 7.4 mm chuck

0 - 250 rpm; 19.0 Nm;  4.0 mm;  
133 x 35 mm;  280 g

consisting parts:  
key GA031R





**GB668R**

**GB496R**

### Acculan 4 reamer attachment

with large AO chuck

0 - 250 rpm; 19.0 Nm;  4.0 mm;  
108 x 35 mm;  300 g





**GB669R**

**GB496R**

### Acculan 4 reamer attachment

with Hudson/Zimmer chuck

0 - 250 rpm; 19.0 Nm;  4.0 mm;  
118 x 35 mm;  300 g





**GB670R**

**GB496R**

### Acculan 4 reamer attachment

with Harris chuck

0 - 250 rpm; 19.0 Nm;  4.0 mm;  
106 x 35 mm;  290 g





**GB660R**

**GB496R**

**Acculan sagittal saw attachment**

for Acculan rapid action saw blades  
with a maximum useable length of  
50 mm

«» 0 - 17,000 rpm;  $\sphericalangle$  4°47';  
89 x 36 x 44 mm;  $\text{♁}$  270 g



**GB641R**

**GB496R**

**Acculan K-wire attachment**

for K-wires from 0.6 - 4.0 mm

0 - 1,250 rpm; 93 x 36 x 137 mm;  
 $\text{♁}$  285 g



# AESCULAP® Acculan 4

## Oscillating saws

**GA331**

**GB495R**

### Acculan 4 oscillating saw

250 W;  $\leftrightarrow$  0 - 13,000 rpm;  $\sphericalangle$  4.1°;  
211 x 177 x 55 mm;  $\boxplus$  1,600 g

consisting parts:  
GA678 sterile funnel

Lid GA675 and NiMH battery GA676 to  
be ordered separately.

Measurements and weight are including  
battery and lid.



**GA336**

**GB498R**

### Acculan 4 oscillating saw straight

250 W;  $\leftrightarrow$  0 - 13,000 rpm;  $\sphericalangle$  4.1°;  
290 x 55 x 84 mm;  $\boxplus$  1,480 g

consisting parts:  
GA678 sterile funnel

Lid GA675 and NiMH battery GA676 to  
be ordered separately.

Measurements and weight are including  
battery and lid.



**GA337**

**GB498R**

### Acculan 4 oscillating sternum saw

250 W;  $\leftrightarrow$  0 - 13,000 rpm;  $\sphericalangle$  4.1°;  
290 x 55 x 84 mm;  $\boxplus$  1,480 g

consisting parts:  
GA678 sterile funnel

Lid GA675 and NiMH battery GA676 to  
be ordered separately.

Measurements and weight are including  
battery and lid.



## Reciprocating saw

**GA334**

**GB495R**

### Acculan 4 reciprocating saw

250 W; ↔ 0 - 15,000 rpm; ↓ 3.2 mm;  
207 x 180 x 55 mm; ⚖ 1,540 g

consisting parts:

GA678 sterile funnel

GB440215 cleaning plate

GA674890 cleaning adapter

Lid GA675 and NiMH battery GA676 to  
be ordered separately.

Measurements and weight are including  
battery and lid.



**GB436R**

**GB686R**

### Protection guide

for use with GA334 and saw blade  
GC761R



# AESCULAP® Acculan 4

## Dermatome

**GA340**

**GB498R**

### Acculan 4 dermatome

width keyless adjustable;  
thickness adjustable (1 / 10 mm steps);  
cutting thickness: 0.2 - 1.2 mm;  
cutting width: max. 78 mm;  
suitable blades: GB228R  
(to be ordered separately)

250 W; ↔ 0 - 6,500 rpm; ↑↓ 3.1 mm;  
277 x 113 x 83 mm; ⚖ 1,650 g

consisting parts:  
GA678 sterile funnel

Lid GA675 and small Li-Ion battery  
GA346 to be ordered separately.

Measurements and weight are including  
battery and lid.



**GA341**

**GB498R**

### Acculan 4 dermatome 0.1 mm

width keyless adjustable;  
thickness adjustable (1 / 10 mm steps);  
cutting thickness: 0.1 - 1.1 mm;  
cutting width: max. 78 mm;  
suitable blades: GB228R  
(to be ordered separately)

250 W; ↔ 0 - 6,500 rpm; ↑↓ 3.1 mm;  
277 x 113 x 83 mm; ⚖ 1,650 g

consisting parts:  
GA678 sterile funnel

Lid GA675 and small Li-Ion battery  
GA346 to be ordered separately.

Measurements and weight are including  
battery and lid.



**BA720R**

**GB688R**

### Skin graft mesher

for use in combination with skin graft  
carrier plates BA721, BA722, BA723  
(factors 1.5, 3.0, 6.0)

150 x 195 x 105 mm; ⚖ 4,800 g

consisting parts:  
BA725R cutting roller  
BA726R ratchet wrench



# AESCULAP® Acculan 4

Look. Feel. Experience.

Acculan 4 small drill – the smallest member of the Acculan 4 family can be used for small fragment Osteosynthesis as well as for reamed intramedullary nailing.



# AESCULAP® Acculan 4

## Small drill

### Drill & attachments

**GA344**

**GB482R**

#### Acculan 4 small drill

with oscillating and tapping mode;  
not for use with acetabulum reamers

85 W;  ;  3.2 mm;  
177 x 124 x 55 mm;  840 g

consisting parts:

GA678 sterile funnel

GA344244 K-wire protection guide

TA011944 cleaning brush

GA344211 rinsing adapter

GB600880 Sterilit® spray adapter

Lid GA675 and small Li-Ion battery  
GA346 to be ordered separately.

Measurements and weight are including  
battery and lid.





**GB870R**

**GB716R**

#### Intramedullary reamer attachment

with Jacobs chuck 0.5 - 7.4 mm,  
not for use with acetabulum reamers

0 - 320 rpm; 5 Nm;  3.2 mm;  
105 x 29 mm;  230 g

consisting parts:

key GA031R





**GB871R**

**GB716R**

#### Intramedullary reamer attachment

with large AO chuck,  
not for use with acetabulum reamers

0 - 320 rpm; 5 Nm;  3.2 mm;  
88 x 29 mm;  170 g





**GB872R**

**GB716R**

#### Intramedullary reamer attachment

with Hudson/Zimmer chuck,  
not for use with acetabulum reamers

0 - 320 rpm; 5 Nm;  3.2 mm;  
86 x 25 mm;  150 g





## Small drill Attachments

**GB881R**

**GB716R**

### Drill attachment

with Jacobs chuck 0.5 - 7.4 mm

0 - 1,250 rpm; 1.5 Nm;  3.2 mm;  
89 x 29 mm;  163 g

consisting parts:  
key GA031R





**GB882R**

**GB716R**

### Drill attachment

with Jacobs chuck 0.5 - 4 mm

0 - 1,250 rpm; 1.5 Nm;  3.2 mm;  
76 x 22 mm;  100 g

consisting parts:  
key GA062R





**GB884R**

**GB716R**

### Drill attachment

with small AO chuck

0 - 1,250 rpm; 1.5 Nm;  2.8 mm;  
60 x 22 mm;  66 g





**GB886R**

**GB716R**

### Drill attachment

with AESCULAP® hexagonal chuck

0 - 1,250 rpm; 1.5 Nm;  3.2 mm;  
57 x 24 mm;  67 g





**GB887R**

**GB716R**

### Drill attachment

with Dental shank

0 - 1,250 rpm; 1.5 Nm;  1.8 mm;  
56 x 22 mm;  50 g



# AESCULAP® Acculan 4

## Small drill Attachments

**GB878R**

**GB716R**

### Drill attachment

for Synthes radiolucent drive 511.300

0 - 1,250 rpm; 1.5 Nm;  
111 x 27 mm; 181 g



**GB894R**

**GB716R**

### K-wire attachment

for K-wires from 0.6 - 3.2 mm

0 - 1,250 rpm; 3.2 mm;  
92 x 27 x 124 mm; 179 g



**GB891R**

**GB716R**

### Sagittal saw attachment

for "L-sagittal" sawblades

0 - 15,750 rpm; 74 x 33.5 mm;  
4.5°; 179 g



**GB892R**

**GB716R**

### Reciprocating saw attachment

for reciprocating saw blades

0 - 15,750 rpm; 135 x 24.5 mm;  
166 g; 2.5 mm







**GB896R**

**GB716R**

**Screw attachment**

with small AO chuck

0 - 165 rpm; 10 Nm;  1.7 mm;  
95 x 28 x 129.5 mm;  235 g





**GB897R**

**GB716R**

**Screw attachment**

with AESCULAP® hexagonal chuck

0 - 165 rpm; 10 Nm;  1.7 mm;  
92 x 28 x 129.5 mm;  231 g



# AESCLAP® Acculan 4

## Charger & batteries

### GA320

#### Acculan 4 charger

for Acculan Li-Ion and NiMH batteries  
GA346, GA676; 4 charging bays;  
automatic battery diagnosis function  
100 - 240 V AC; 50 / 60 Hz;  
410 x 120 x 160 mm; 2,300 g  
power cord not included



### GA346

#### Acculan 4 Li-Ion battery short

only for GA340, GA341 and GA344;  
with integrated electronic motor  
control 9.9 V; 10.89 Wh  
120 x 43 x 50 mm; 265 g



### GA676

#### Acculan NiMH battery

only for GA330, GA331, GA334, GA336,  
GA337; with integrated electronic  
motor control 9.6 V; 1.95 Ah  
140 x 43 x 50 mm; 425 g



### GA679

### GB489R

#### Acculan battery removal device



### GA675

### GB487R

#### Acculan lid

90 g



### GA678

### GB488R

#### Acculan sterile funnel





# AESCULAP® Acculan 4 Electro

Look. Feel. Experience.



## Console & batteries

**GA877**

**Acculan Electro console**

power cord not included

100 - 240 V AC; 50 / 60 Hz;  
255 x 217 x 90 mm; 2,930 g

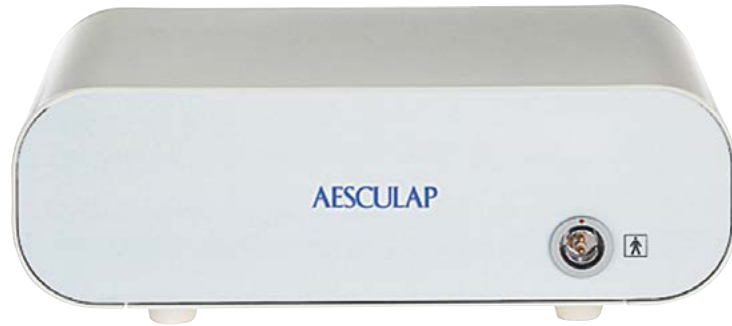

**GA878**

**GB486R**

**Acculan Electro connection cable**  
for use with Acculan 4 handpieces

3.0 m; 410 g



**GA875**

**GB485R**

**Acculan Electro lid**



**GA876**

**Acculan Electro adapter**

120 x 49 x 42 mm; 165 g



**GA678**

















**GB488R**

**Acculan sterile funnel**



# AESCULAP® Acculan 4 Accessories

## Adapters, keys & power cord

<p><b>GB176R</b> <span style="float: right;">GB690R</span></p> <p><b>Zimmer adapter</b>            tool: Zimmer            motor: Hudson/Zimmer            only in combination with GB630R,            GB656R, GB665R, GB669R or GB872R   3.0 mm</p>	<p><b>GB414R</b> <span style="float: right;">JG344</span></p> <p><b>AESCULAP® hex adapter</b>            tool: AESCULAP® hexagonal            motor: triangular   3.5 mm</p>	<p><b>GB628R</b> <span style="float: right;">JG344</span></p> <p><b>Synthes DHS/DCS adapter</b>            tool: Synthes DHS/DCS            motor: AO large   4.0 mm</p>	
			
<p><b>GB184R</b> <span style="float: right;">JG344</span></p> <p><b>Harris adapter</b>            tool: Harris            motor: AO large   3.4 mm</p>	<p><b>XF457R</b> <span style="float: right;">JG344</span></p> <p><b>DIN adapter</b>            tool: DIN            motor: AO large   3.7 mm</p>	<p><b>GA031R</b> <span style="float: right;">JG342 + JG344</span></p> <p><b>Key</b>            for large Jacobs chuck            suitable for GB620R, GB621R,            GB667R, GB870R, GB881R</p>	
			
<p><b>GA062R</b> <span style="float: right;">JG342</span></p> <p><b>Key</b>            for small 4 mm Jacobs chuck            suitable for GB639R, GB882R</p>			
			
<p><b>TE780</b></p>	<p><b>TE734</b></p>		
<p><b>Power cord</b>            Europe,  1.5 m</p>	<p><b>Power cord</b>            UK,  5.0 m</p>		
<p><b>TE730</b></p>	<p><b>TE735</b></p>		
<p><b>Power cord</b>            Europe,  5.0 m</p>	<p><b>Power cord</b>            USA, Canada, Japan,  3.5 m</p>		

# AESCULAP® Processing

Sterilit® power systems



# AESCALAP® Processing

## Sterilit® power systems

GB600



Sterilit® power systems  
oil spray; 300 ml



GB600860

Sterilit® power systems spray  
adapter

for ELAN 4 electro



GB600870

Sterilit® power systems spray  
adapter

for ELAN 4 MIS handpiece shafts



GB600840

Sterilit® power systems spray  
adapter

for Acculan 4



GB600880

Sterilit® power systems spray  
adapter

for Acculan 4 small drill and ELAN 4  
electro drill





# AESFULAP® Mechanical Processing

- The solution for storage and mechanical reprocessing of our Aesculap® Power Systems.
- For detailed information please refer to the instructions for use.



# AESCULAP® Mechanical Processing

## ECCOS® sets

### ELAN 4

#### GB261R

##### ELAN 4 electro ECCOS® set

 56 mm

consisting parts:

GB073R

GB076R

GB083R

GB085R

GB719R

GB072R

JF212R

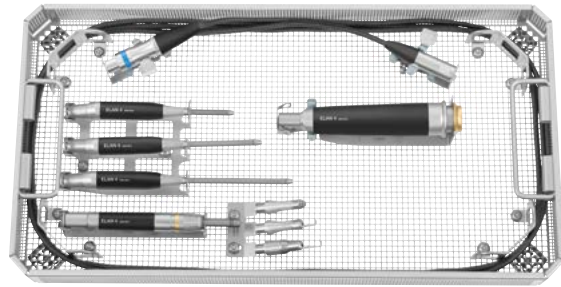

#### GB262R

##### ELAN 4 electro ECCOS® set for drill GA844

 106 mm

consisting parts:

GB072R

GB073R

GB482R

GB715R

GB716R

2x GB690R





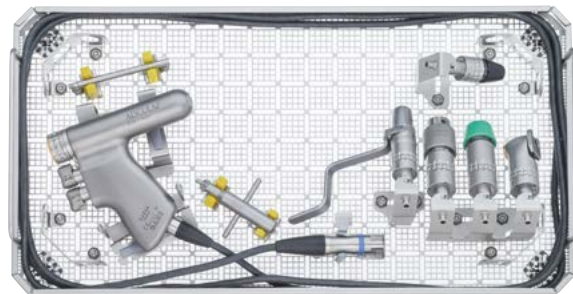



















JG342

JG344

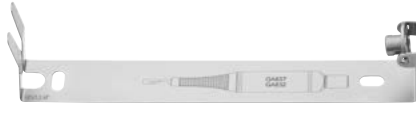

# ECCOS®

## ELAN 4 electro

<p><b>GB073R</b></p> <p><b>ECCOS® holder</b> for motor cable GA804, GA805, GA806 (set consisting of 2 pieces)</p>  56 mm	<p><b>GB076R</b></p> <p><b>ECCOS® holder</b> for perforator driver GA822</p>  56 mm	<p><b>GB077R</b></p> <p><b>ECCOS® holder</b> for intra motor GA824</p>  56 mm
 	 	 
<p><b>GB082R</b></p> <p><b>ECCOS® holder</b> for 1 handpiece</p>  56 mm	<p><b>GB083R</b></p> <p><b>ECCOS® holder</b> for 3 handpieces</p>  56 mm	<p><b>GB085R</b></p> <p><b>ECCOS® holder</b> for craniotome GA849</p>  56 mm
 	 	 
<p><b>GB086R</b></p> <p><b>ECCOS® holder</b> for micro sagittal saw GA836</p>  56 mm	<p><b>GB087R</b></p> <p><b>ECCOS® holder</b> for reciprocating saws GA832, GA837</p>  56 mm	<p><b>GB088R</b></p> <p><b>ECCOS® holder</b> for saws GA831, GA833</p>  56 mm
 	 	 

# AESCULAP® Mechanical Processing

ECCOS®  
ELAN 4 electro

GB482R	GB715R	GB716R
<p><b>ECCOS® holder</b> for ELAN 4 electro drill GA844</p>  106 mm	<p><b>ECCOS® holder</b> for 1 attachment GB870R, GB871R, GB872R, GB878R, GB881R, GB884R, GB892R, GB896R, GB897R</p>  106 mm	<p><b>ECCOS® holder</b> for 3 attachments GB870R, GB871R, GB872R, GB878R, GB881R, GB884R, GB892R, GB896R, GB897R</p>  106 mm
 	 	 

# ECCOS® & rinsing devices

## ELAN 4 electro

### GB084R

#### ECCOS® holder

for MIS handpiece GA860

 56 mm

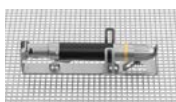

### GB723R

#### ECCOS® holder

for MIS handpiece shafts GB920R - GB927R

 56 mm



### GB692R

#### Rinsing device

for applied parts, incl. ceramic filter GB693   
(not suitable for autoclaving)

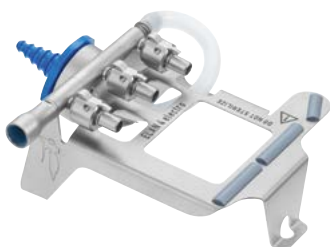

### GB679R

#### Rinsing device

for 4 MIS shafts, incl. ceramic filter GB693   
(not suitable for autoclaving)

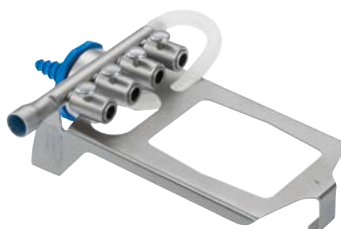

### GB698R

#### Rinsing adapter

for applied parts  
(for manual cleaning)



### GB699R

#### Rinsing adapter

for MIS shafts  
(for manual cleaning)













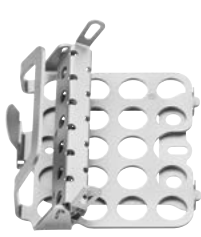











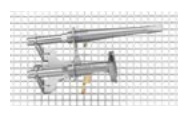

# AESCU LAP<sup>®</sup> Mechanical Processing

ECCOS<sup>®</sup>

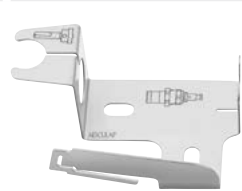
ELAN 4 accessories

<p><b>GB718R</b></p> <p><b>ECCOS<sup>®</sup> holder</b> for 12 1- and 2-ring burrs</p>  56 mm	<p><b>GB719R</b></p> <p><b>ECCOS<sup>®</sup> holder</b> for 3 craniotome attachments</p>  56 mm	<p><b>GB720R</b></p> <p><b>ECCOS<sup>®</sup> universal holder</b> for saw blades</p>  56 mm
 	 	 
<p><b>GB729R</b></p> <p><b>ECCOS<sup>®</sup> holder</b> for 2 reciprocating saw shafts</p>  56 mm	<p><b>GB730R</b></p> <p><b>ECCOS<sup>®</sup> holder</b> for 2 transversal saw shafts</p>  56 mm	<p><b>GB072R</b></p> <p><b>ECCOS<sup>®</sup> cable/hose pos. guide</b> for cable and hoses (set of 4 pieces)</p>  56 mm
 	 	 
<p><b>GB727R</b></p> <p><b>ECCOS<sup>®</sup> holder</b> for handpiece holding-sleeves GB861P, GB862P, GB863P</p>  56 mm	<p><b>GB572R</b></p> <p><b>ECCOS<sup>®</sup> fixation</b> for GB300R - GB304R</p>  56 mm	
 	 	

# ECCOS® sets

## Acculan 4

### GB257R

#### ECCOS® set

for Acculan 4 small drill GA344

 106 mm

consisting parts:

GB482R

GB487R

GB488R

GB715R

GB716R

2x GB690R

JG342

JG344

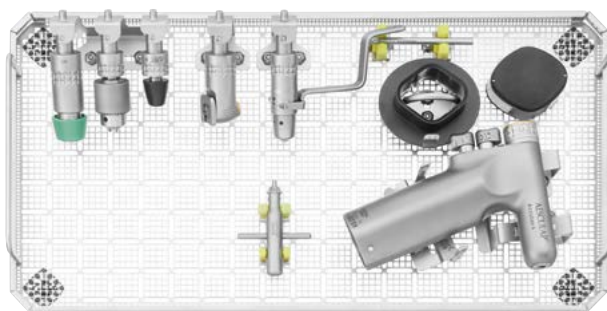

### GB243R

#### ECCOS® set

for 2 Acculan 4 machines

 106 mm

consisting parts:

GB481R

GB487R

GB488R

GB495R

GB496R

GB497R

2x GB690R

JG342

JG344

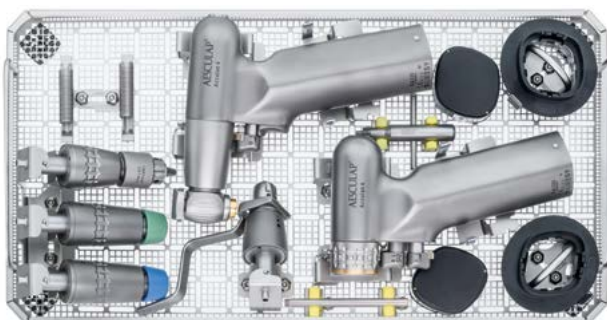

### GB256R

#### ECCOS® set

for Acculan 4 dermatome

 106 mm

consisting parts:

GB487R

GB488R

GB498R

















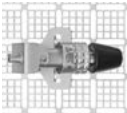

JJ464R



# AESCULAP® Mechanical Processing

ECCOS®

Acculan 4

GB482R	GB715R	GB716R
<p><b>ECCOS® holder</b> for Acculan 4 small drill GA344</p>  106 mm	<p><b>ECCOS® holder</b> for 1 attachment GB870R, GB871R, GB872R, GB878R, GB881R, GB884R, GB892R, GB896R, GB897R</p>  106 mm	<p><b>ECCOS® holder</b> for 3 attachments GB870R, GB871R, GB872R, GB878R, GB881R, GB884R, GB892R, GB896R, GB897R</p>  106 mm
 	 	 
GB495R	GB496R	GB497R
<p><b>ECCOS® holder</b> for GA330, GA331, GA334</p>  106 mm	<p><b>ECCOS® holder</b> for GB620R, GB621R, GB623R, GB639R, GB641R, GB645R GB660R, GB663R, GB664R, GB665R, GB657R, GB667R, GB668R, GB669R, GB670R</p>  106 mm	<p><b>ECCOS® holder</b> for GB620R, GB621R, GB623R, GB639R, GB641R, GB645R GB660R, GB663R, GB664R, GB665R, GB657R, GB667R, GB668R, GB669R, GB670R</p>  106 mm
 	 	 



GB487R	GB488R	GB489R
--------	--------	--------

**ECCOS® holder**  
for GA675  
 56 mm

**ECCOS® holder**  
for GA678  
 76 mm

**ECCOS® holder**  
for GA679  
 106 mm

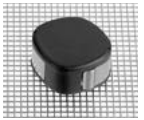

GB498R	GB686R
--------	--------

**ECCOS® holder**  
for GA336, GA337, GA340, GA341  
 106 mm



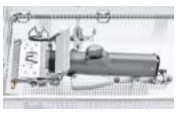









**ECCOS® holder**  
for GB436R  
 56 mm

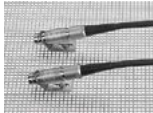
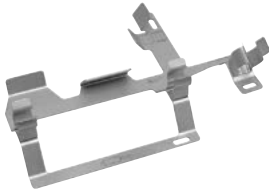

# AESCULAP® Mechanical Processing





## ECCOS® holder

Acculan 4

GB485R	GB486R	GB688R
<p>ECCOS® holder for GA875</p>  56 mm	<p>ECCOS® holder for GA878</p>  56 mm	<p>ECCOS® holder for BA720R</p>  106 mm
 	 	 
GB481R	JF148R	
<p>ECCOS® holder for saw blades and other accessories</p>  56 mm	<p>Mini tray with lid outer size: 145 x 44 x 25 mm inner size: 140 x 39 x 18 mm for storage of Acculan 4 Dermatome rod and flaps during automatic cleaning process</p>	
 		

# ECCOS® holder

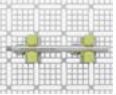
## Universal tools

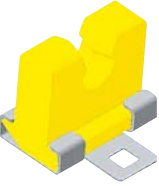
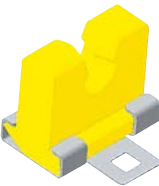
<p><b>GB459R</b></p> <p><b>ECCOS® &amp; Aesculap InOS® mounting kit</b>          consisting of:          socket wrench AF7 and          hex-wrench</p>	<p><b>GB690R</b></p> <p><b>ECCOS® holder</b>          5 mm          for drilling wire guide GA672207,          GA344244</p>	<p><b>JG303R</b> </p> <p><b>Replacement screws-set</b>          screw nut size AF7</p>
	 	
<p><b>JG342</b></p> <p><b>Silicone clamp</b>          8.5 mm          screw JG303R to be ordered          separately</p>	<p><b>JG344</b></p> <p><b>Silicone clamp</b>          12 mm          screw JG303R to be ordered          separately</p>	
		

# AESCULAP® Power Systems

## Tool attachments overview

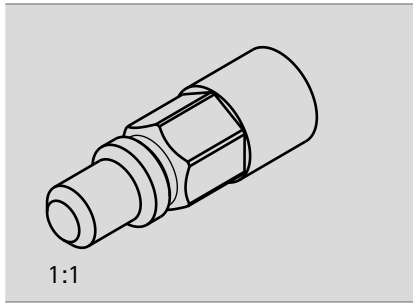

AO large

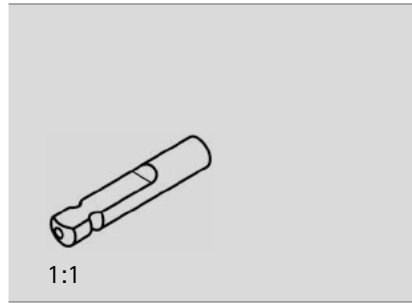

AO small

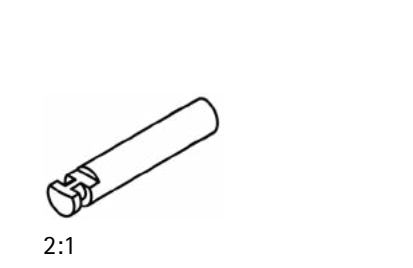

Dental

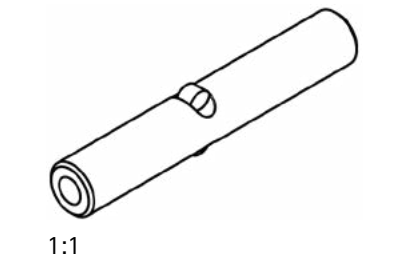

DIN

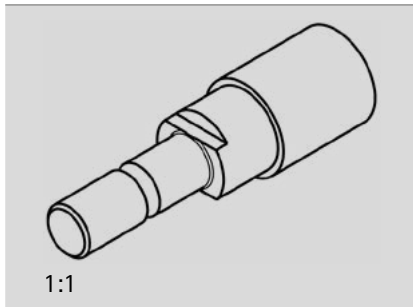

Harris

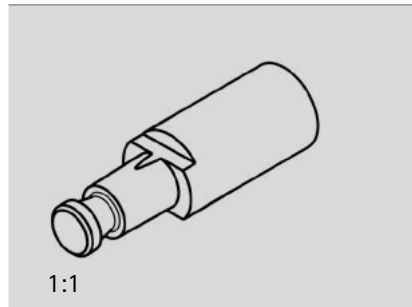

Hudson

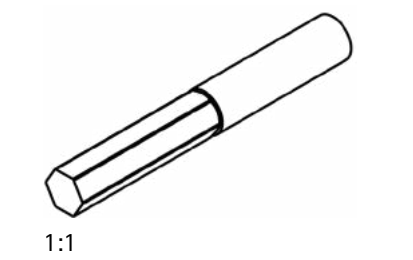

Hexagon

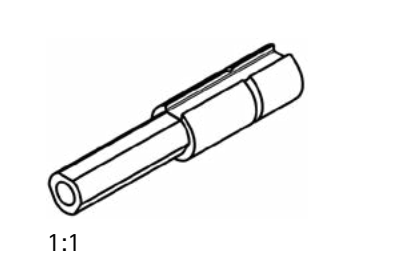

Synthes  
DHS/DCS

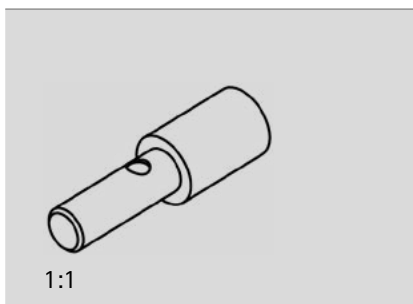



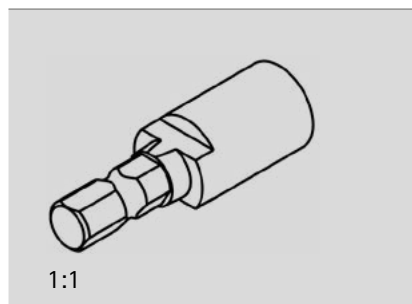









Trinkle

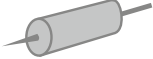

Zimmer

## Signs & symbols

	<p>Latex-free</p> <p>All products listed in this catalogue are latex-free</p>
	<p>Article code ECCOS® fixation</p>
	<p>Forward / reverse drive</p>
	<p>Forward drive</p>
	<p>Oscillation frequency</p>
	<p>Oscillation angle</p>
	<p>Stroke</p>
	<p>Cannulation</p>
	<p>Cable length</p>
	<p>Weight</p>
	<p>Packaging unit</p>
	<p>Single use</p>
	<p>Required height of tray</p>
	<p>Sterile</p>

# AESCULAP® Power Systems

## Brochures

### Main Catalogues

**084002**  
Power Systems



**017599**  
Burs & Blades



**CLICK HERE**  
for Electronic Instructions for Use (eIFU)

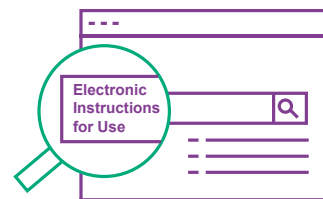

### ELAN 4

**071602**  
ELAN 4



**071511**  
Mechanical Cleaning



**012002**  
Manual Cleaning



### Acculan 4

**001802**  
Acculan 4

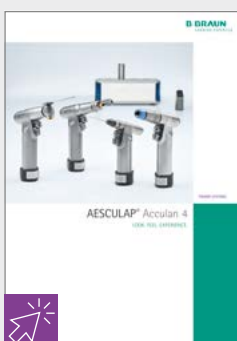

**001902**  
Acculan 4 Dermatomy

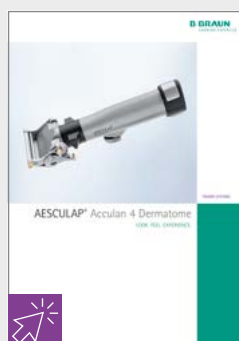

**002002**  
Acculan 4 Electro

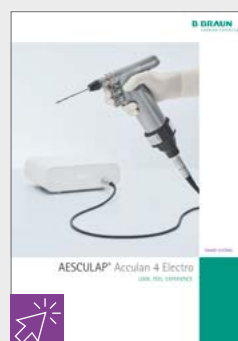

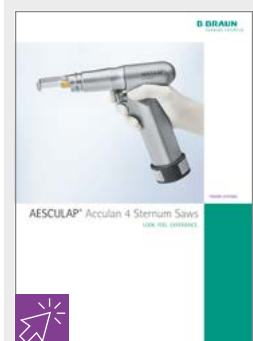

**002102**  
Acculan 4 Sternum Saws



# Index

Art. No.	
BA720R	32
GA031R	42
GA062R	42
GA258SU	23
GA259SU	23
GA261SU	23
GA262SU	23
GA263SU	23
GA264SU	23
GA265SU	23
GA266SU	23
GA267SU	23
GA268SU	23
GA269SU	23
GA320	38
GA330	26
GA331	30
GA334	31
GA336	30
GA337	30
GA340	32
GA341	32
GA344	34
GA346	38
GA395SU	23
GA675	38
GA676	38
GA678	38, 41
GA679	38
GA800	7
GA804	8
GA805	8
GA806	7
GA808	7
GA810	7
GA822	8
GA824	8
GA831	15
GA832	15
GA833	15
GA836	15
GA837	15
GA844	17
GA849	9
GA860	13
GA861	10
GA862	10
GA863	10
GA864	10
GA865	11

Art. No.	
GA866	11
GA867	11
GA868	11
GA869	11
GA875	41
GA876	41
GA877	41
GA878	41
GB072R	50
GB073R	47
GB076R	47
GB077R	47
GB082R	47
GB083R	47
GB084R	49
GB085R	47
GB086R	47
GB087R	47
GB088R	47
GB176R	42
GB184R	42
GB243R	51
GB256R	51
GB257R	51
GB261R	46
GB262R	46
GB414R	42
GB436R	31
GB459R	55
GB481R	54
GB482R	48, 52
GB485R	54
GB486R	54
GB487R	53
GB488R	53
GB489R	53
GB495R	52
GB496R	52
GB497R	52
GB498R	53
GB572R	50
GB600	44
GB600840	44
GB600860	44
GB600870	44
GB600880	44
GB620R	26
GB621R	26
GB623R	26
GB628R	42

Art. No.	
GB639R	27
GB641R	29
GB645R	27
GB657R	28
GB660R	29
GB663R	27
GB664R	27
GB665R	27
GB667R	28
GB668R	28
GB669R	28
GB670R	28
GB679R	49
GB686R	53
GB688R	54
GB690R	55
GB692R	49
GB698R	49
GB699R	49
GB715R	48, 52
GB716R	48, 52
GB718R	50
GB719R	50
GB720R	50
GB723R	49
GB727R	50
GB729R	50
GB730R	50
GB796SU	23
GB797SU	23
GB861P	22
GB862P	22
GB863P	22
GB866R	22
GB870R	17, 34
GB871R	17, 34
GB872R	17, 34
GB878R	19, 36
GB881R	18, 35
GB882R	18, 35
GB884R	18, 35
GB886R	18, 35
GB887R	18, 35
GB891R	19, 36
GB892R	19, 36
GB894R	19, 36
GB896R	20, 37
GB897R	20, 37
GB920R	13
GB921R	13

Art. No.	
GB922R	13
GB925R	13
GB926R	13
GB927R	13
GB941R	9
GB942R	9
GB943R	9
GB945R	9
GB947R	9
JF148R	54
JF212R	46
JG303R	55
JG342	55
JG344	46, 55
TE730	22, 42
TE734	22, 42
TE735	22, 42
TE780	22, 42
XF457R	42

# AESFULAP<sup>®</sup> – a B. Braun brand

Aesculap AG | Am Aesculap-Platz | 78532 Tuttlingen | Germany  
Phone +49 7461 95-0 | Fax +49 7461 95-2600 | [www.aesculap.com](http://www.aesculap.com)

The main product trademark "AESFULAP" and the product trademarks "Aesculap InOS", "ECCOS" and "Sterilit" are registered trademarks of Aesculap AG.

Subject to technical changes. All rights reserved. This brochure may only be used for the exclusive purpose of obtaining information about our products. Reproduction in any form partial or otherwise is not permitted.