



WE UNDERSTAND.



NEUROSURGERY

SHUNTASSISTANT[®] 2.0

ADD-ON VALVE FOR THE TREATMENT
OF HYDROCEPHALUS

SHUNTASSISTANT[®] 2.0

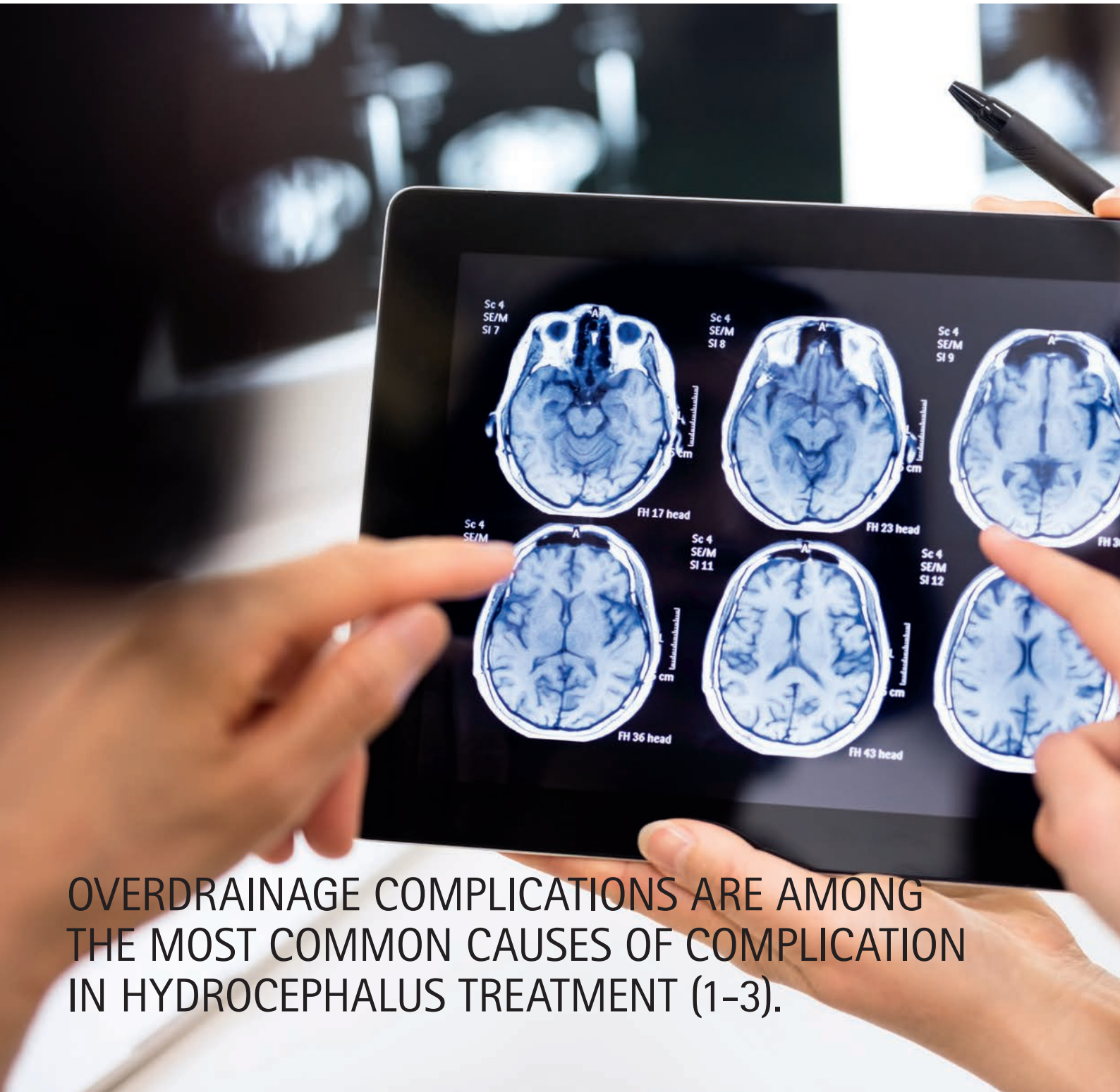

OVERDRAINAGE COMPLICATIONS ARE AMONG THE MOST COMMON CAUSES OF COMPLICATION IN HYDROCEPHALUS TREATMENT (1-3).



On average at least every 5th shunted patient experiences overdrainage (2, 4).



Common valve technology does not protect sufficiently against overdrainage symptoms.



Overdrainage can cause severe situations such as hygromas and hematomas.

- (1) Freimann FB, Sprung C. Shunting with gravitational valves—can adjustments end the era of revisions for overdrainage-related events? *J Neurosurg.* 2012 Dec;117(6):1197-204.
- (2) Lemcke J, Meier U, Müller C, Fritsch MJ, Kehler U, Langer N, Kiefer M, Eymann R, Schuhmann MU, Speil A, Weber F, Remenez V, Rohde V, Ludwig HC, Stengel D. Safety and efficacy of gravitational shunt valves in patients with idiopathic normal pressure hydrocephalus: a pragmatic, randomised, open label, multicentre trial (SVASONA). *J Neurol Neurosurg Psychiatry.* 2013 Aug;84(8):850-7.
- (3) Sundstrom N, Lagebrant M, Eklund A, Koskinen LD, Malm J. Subdural hematomas in 1846 patients with shunted idiopathic normal pressure hydrocephalus: treatment and long-term survival. *J Neurosurg.* 2017 Oct;27:1-8.
- (4) Boon AJ, Tans JT, Delwel EJ, Egeler-Peerdeman SM, Hanlo PW, Wurzer HA, Avezaat CJ, de Jong DA, Gooskens RH, Hermans J. Dutch Normal-Pressure Hydrocephalus Study: randomized comparison of low- and medium-pressure shunts. *J Neurosurg.* 1998 Mar;88(3):490-5.

SHUNTASSISTANT® 2.0

THE VALVE

GRAVITATIONAL TECHNOLOGY

Depending on the body position of the patient the *SHUNTASSISTANT*® 2.0 gradually adapts the opening pressure automatically and counteracts possible overdrainage.

COMBINATION WITH DIFFERENTIAL PRESSURE VALVES

SHUNTASSISTANT® 2.0 proves its strength in combination with other valves. As overdrainage protection, it can be combined with differential pressure valves (even adjustable), either as an initial solution or as a secondary add-on device for patients with existing complications.

DESIGN

The slim, cylindric design enables a fast and easy implantation and is suitable for adults as well as pediatric hydrocephalus treatment.



ADDITIONAL LP-VARIANTS

SHUNTASSISTANT® 2.0 LP, STRAIGHT

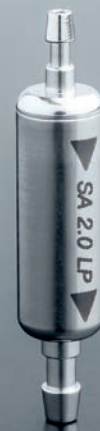

SHUNTASSISTANT® 2.0 LP WITH DEFLECTION, U-FORM



SHUNTASSISTANT® 2.0

FUNCTION AND BODY POSITION

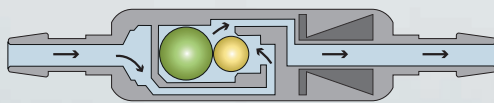
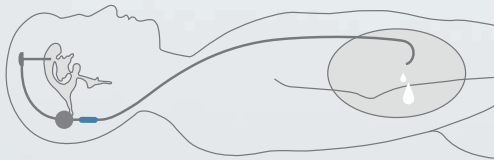

Valve opening pressure
(cmH₂O)

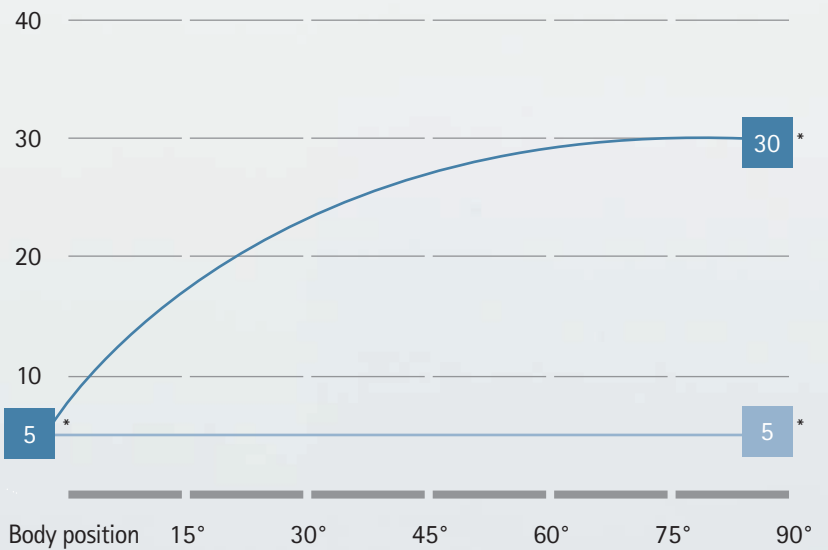

— with SHUNTASSISTANT® 2.0

— without SHUNTASSISTANT® 2.0

* In the example shown an additional differential pressure valve with opening pressure of 5 cmH₂O, as well as SHUNTASSISTANT® 2.0 with 25 cmH₂O have been selected.

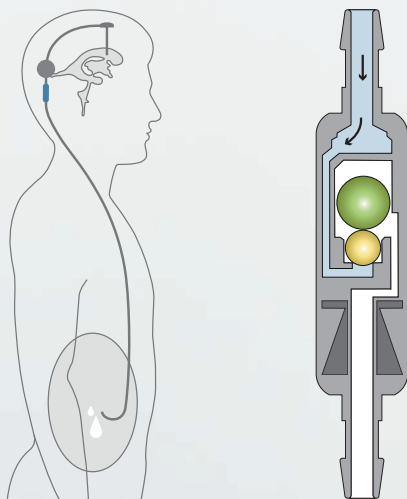

HORIZONTAL BODY POSITION

In the horizontal position, the *SHUNTASSISTANT*® 2.0 is always open and does not present any resistance. The opening pressure is exclusively determined by an additional differential pressure valve in this body position.

An implantation parallel to the body axis of the patient, ensures a precise and reliable performance of the *SHUNTASSISTANT*® 2.0.

VERTICAL BODY POSITION

When the patient moves into an upright position, the *SHUNTASSISTANT*® 2.0 is activated by the tantalum ball (presented in green) and adapts the valve opening pressure automatically.

The *SHUNTASSISTANT*® 2.0 and the additional differential pressure valve form the total sum of valve opening pressure.

The functionality of *SHUNTASSITANT*® 2.0 in different body positions is demonstrated in the Miethke App interactively.



SHUNTASSISTANT[®] 2.0

X-RAY RECOGNITION AND PRESSURE RECOMMENDATION

X-RAY RECOGNITION

The integrated X-ray coding enables a simple detection of the pressure levels after implantation.

PRECISION

The valve material titanium assures high precision, durable reliability and biocompatibility. It prevents effectively external and subcutaneous pressure influences and is MRI compatible.

PRESSURE LEVELS

The 6 pressure levels offered cover the patient spectrum from newborn to the elderly and allow a wide range of applications in the treatment of hydrocephalus.

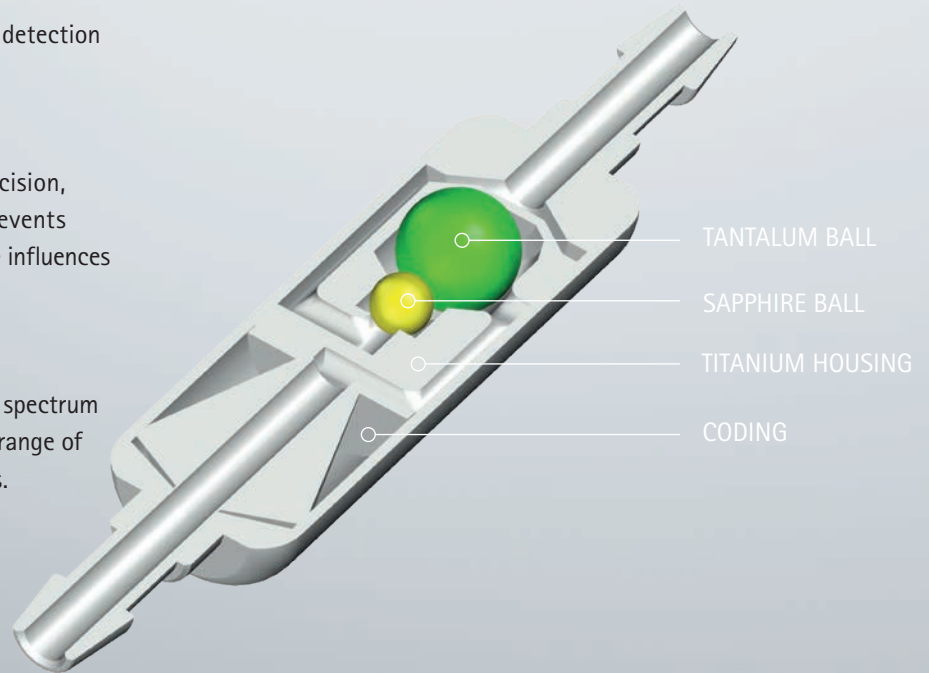

X-RAY CODING

Pressure level	Coding	Radiography
10 cmH ₂ O		
15 cmH ₂ O		
20 cmH ₂ O		
25 cmH ₂ O		
30 cmH ₂ O		
35 cmH ₂ O		

NEWBORN AND CHILDREN UP TO 3 YEARS	CHILDREN FROM 3 YEARS	ADULTS	ADULTS FROM 65 YEARS
20 cmH ₂ O*	25 cmH ₂ O*	25 cmH ₂ O*	20 cmH ₂ O*
		20 cmH ₂ O* < 1.60 m	15 cmH ₂ O* < 1.60 m
		30 cmH ₂ O* > 1.80 m	25 cmH ₂ O* > 1.80 m

* This is a non-binding recommendation. The physician decides in each case individually.

PRESSURE RECOMMENDATION

The choice of the appropriate pressure level of *SHUNTASSISTANT*[®] 2.0 depends on several other factors, including age, degree of activity, size and stature of the patient.

The values given apply to mobile patients. For patients with little mobility or a high BMI, the gravitational unit should be chosen lower than recommended here.

SHUNTASSISTANT® 2.0

SHUNTASSISTANT® 2.0 – VALVE

▪ Valve



Valve: $d_o = 4.2$ mm
Connector: $d_o = 1.9$ mm

Art. No.	Opening pressure
FX100T	10 cmH ₂ O
FX101T	15 cmH ₂ O
FX102T	20 cmH ₂ O
FX103T	25 cmH ₂ O
FX104T	30 cmH ₂ O
FX105T	35 cmH ₂ O

SHUNTASSISTANT® 2.0 – VALVE WITH DISTAL CATHETER

- Valve
with distal catheter (900 mm)

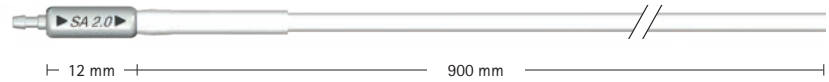

Valve: $d_o = 4.2$ mm
 Connector: $d_o = 1.9$ mm
 Catheter: $d_i = 1.2$ mm, $d_o = 2.5$ mm

Art. No.	Opening pressure
FX118T	10 cmH ₂ O
FX119T	15 cmH ₂ O
FX120T	20 cmH ₂ O
FX121T	25 cmH ₂ O
FX122T	30 cmH ₂ O
FX123T	35 cmH ₂ O

SHUNTASSISTANT® 2.0 LP

SHUNTASSISTANT® 2.0 LP, STRAIGHT

▪ Valve LP, straight

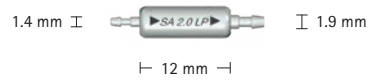

Valve: $d_o = 4.2$ mm
Connector: $d_o = 1.4$ mm
for connection with lumbar catheter
Connector: $d_o = 1.9$ mm
preferably used with
Catheter: $d_i = 1.2$ mm, $d_o = 2.5$ mm

Art. No.	Opening pressure
FX106T	10 cmH ₂ O
FX107T	15 cmH ₂ O
FX108T	20 cmH ₂ O
FX109T	25 cmH ₂ O
FX110T	30 cmH ₂ O
FX111T	35 cmH ₂ O

SHUNTASSISTANT® 2.0 LP, STRAIGHT WITH DISTAL CATHETER

- Valve LP, straight with distal catheter (900 mm)

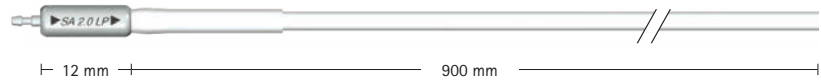

Valve: $d_o = 4.2$ mm
 Connector: $d_o = 1.4$ mm
 for connection with lumbar catheter
 Connector: $d_o = 1.9$ mm
 Catheter: $d_i = 1.2$ mm, $d_o = 2.5$ mm

Art. No.	Opening pressure
FX124T	10 cmH ₂ O
FX125T	15 cmH ₂ O
FX126T	20 cmH ₂ O
FX127T	25 cmH ₂ O
FX128T	30 cmH ₂ O
FX129T	35 cmH ₂ O

SHUNTASSISTANT® 2.0 LP

SHUNTASSISTANT® 2.0 LP, U-FORM

▪ Valve LP, U-Form

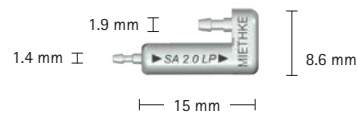

Valve: $d_o = 4.2$ mm
Connector: $d_o = 1.4$ mm
for connection with lumbar catheter
Connector: $d_o = 1.9$ mm
preferably used with
Catheter: $d_i = 1.2$ mm, $d_o = 2.5$ mm

Art. No.	Opening pressure
FX112T	10 cmH ₂ O
FX113T	15 cmH ₂ O
FX114T	20 cmH ₂ O
FX115T	25 cmH ₂ O
FX116T	30 cmH ₂ O
FX117T	35 cmH ₂ O

SHUNTASSISTANT® 2.0 LP, U-FORM WITH DISTAL CATHETER

- Valve LP, U-Form
with distal catheter (900 mm)

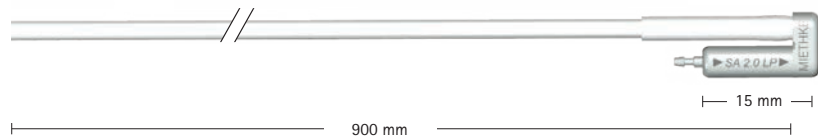

Valve: $d_o = 4.2$ mm
 Connector: $d_o = 1.4$ mm
 for connection with lumbar catheter
 Connector: $d_o = 1.9$ mm
 Catheter: $d_i = 1.2$ mm, $d_o = 2.5$ mm

Art. No.	Opening pressure
FX130T	10 cmH ₂ O
FX131T	15 cmH ₂ O
FX132T	20 cmH ₂ O
FX133T	25 cmH ₂ O
FX134T	30 cmH ₂ O
FX135T	35 cmH ₂ O



NEUROSURGERY

WE UNDERSTAND THE GRAVITY OF THE SITUATION.

GRAVITATIONAL VALVES BY MIETHKE

AESCULAP® – a B. Braun brand

OUR SHUNTSYSTEMS – YOUR CHOICE

proSA®	proGAV® 2.0	GAV® 2.0	SHUNT-ASSISTANT® 2.0 Valve	DUALSWITCH Valve	miniNAV®	Accessories
						

Beschreibung

Adjustable gravitational unit with differential pressure valve	Adjustable differential pressure valve with gravitational unit	Gravitational valve for the treatment of hydrocephalus	Gravitational unit for integration into shunt systems in order to avoid excess drainage	Gravitational valve with large flow volumes for CSF	Differential pressure valve, specifically for premature babies and newborns or bedridden or non-movable patients
--	--	--	---	---	--

Indication

LP		✓	✓	✓		
NPH	✓	✓	✓			
Pediatric HC	✓	✓	✓		✓	
Adult HC	✓	✓	✓		✓	

Patient

Lying	✓				✓	
Active	✓	✓	✓	✓	*	

Feature

3-Tesla MR Conditional	✓	✓	✓	✓	✓	
Gravitational unit	✓	✓	✓	✓		
Adjustable	✓	✓				

* in combination with SHUNTASSISTANT® 2.0 or proSA®



SENSOR RESERVOIR

SENSOR PRECHAMBER

TELEMETRIC SHUNT CONTROL – READING INNER VALUES

AESCLAP® – a B. Braun brand

Aesculap AG | Am Aesculap-Platz | 78532 Tuttlingen | Germany | www.aesculap.com

Manufacturer acc. to MDD 93/42/EEC

■ **CHRISTOPH MIETHKE GMBH & CO. KG**

Christoph Miethke GmbH & Co. KG | Ulanenweg 2 | 14469 Potsdam | Germany
Phone +49 331 62083-0 | Fax +49 331 62083-40 | www.miethke.com

AESCULAP[®] – a B. Braun brand

Distributed by

Aesculap AG | Am Aesculap-Platz | 78532 Tuttlingen | Germany
Phone +49 7461 95-0 | Fax +49 7461 95-2600 | www.aesculap.com

The product trademarks "GAV", "miniNAV", "proGAV", "proSA" and "SHUNTASSISTANT" are registered trademarks of Christoph Miethke GmbH & Co. KG in the majority of the world. For more detailed information please contact us: info@miethke.com.

The main product trademark "Aesculap" is a registered trademark of Aesculap AG.

Subject to technical changes. All rights reserved. This brochure may only be used for the exclusive purpose of obtaining information about our products. Reproduction in any form partial or otherwise is not permitted.