



WE UNDERSTAND.

NEUROSURGERY

***proGAV*[®] 2.0**
IN TOUCH WITH YOU

proGAV[®] 2.0

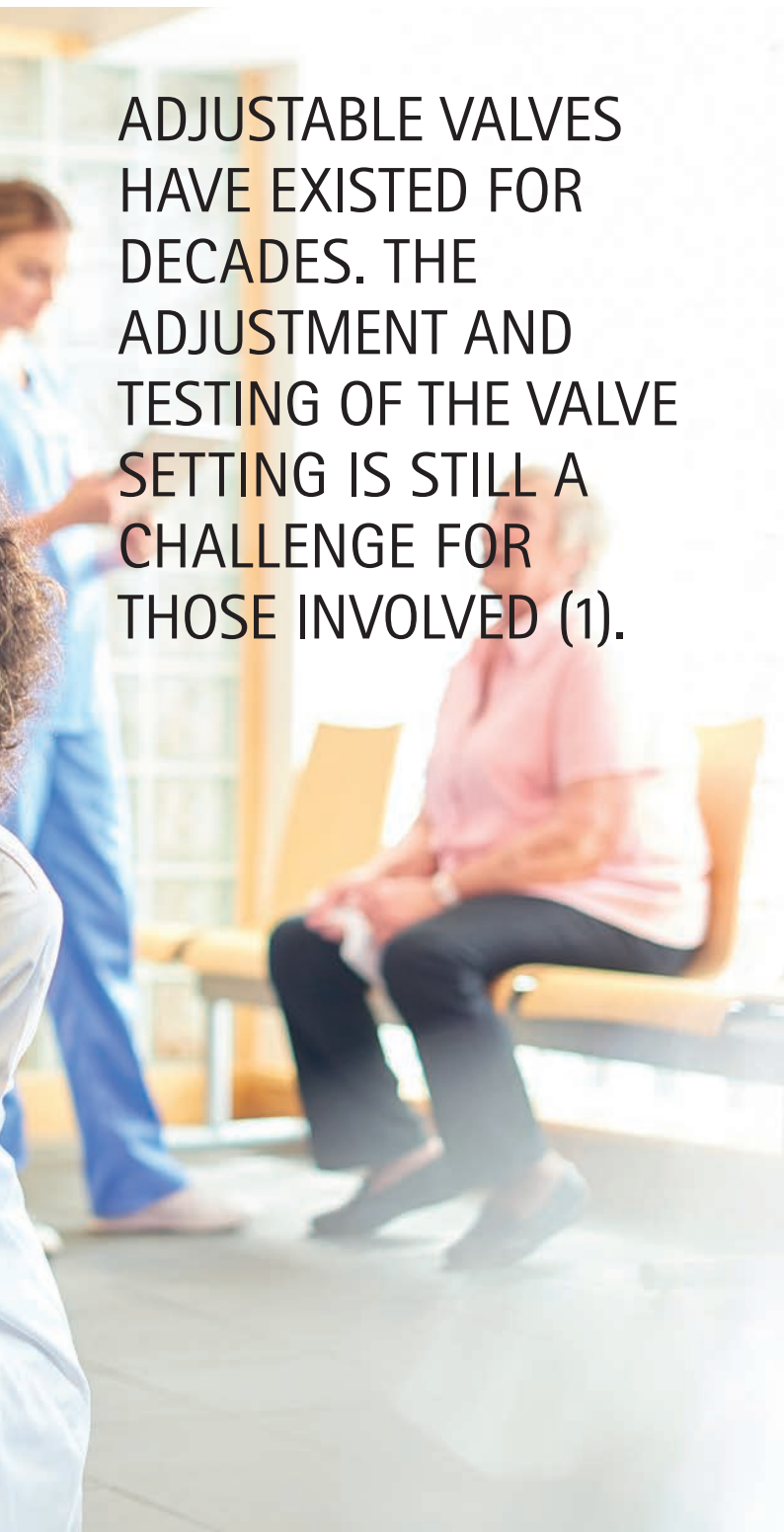

A blurred background image of a hospital waiting area. A woman in a pink shirt is sitting on a yellow chair, and a nurse in blue scrubs is standing nearby. The scene is brightly lit with large windows in the background.

ADJUSTABLE VALVES
HAVE EXISTED FOR
DECADES. THE
ADJUSTMENT AND
TESTING OF THE VALVE
SETTING IS STILL A
CHALLENGE FOR
THOSE INVOLVED (1).



Valve adjustments are performed postoperatively in 45% of the cases.

In 19 - 44% of the cases further pressure adjustments will follow during later treatment (1, 2).



Every valve adjustment is a challenge, both for the patient and the treating hospital staff. Diagnosis and adjustments are often only possible after a radiological examination, which is both time-consuming and costly. In addition to the journey to the clinic, the patient has to wait for treatment, often also accept radiation exposure (1). This makes it all the more important that valve adjustments are user-friendly and convenient.

(1) Bailey NO, Luciano M, Ward MV, Lilienfeld S, Anderson WN, Black P. A Nonradiographic System for Assessing Pressure for the Codman-Hakim Programmable Valve. *Neurosurgery*. 2010 Sep;67(3 Suppl Operative):ons96-100; discussion ons100-1.

(2) Sprung C, Schlosser HG, Lemcke J, Meier U, Messing-Jünger M, Trost HA, Weber F, Schul C, Rohde V, Ludwig HC, Höpfner J, Sepehrnia A, Mirzayan MJ, Krauss JK. The adjustable proGAV shunt: a prospective safety and reliability multicenter study. *Neurosurgery*. 2010 Mar;66(3):465-74.

proGAV[®] 2.0

VALVE AND SOFT TOUCH TOOLS

USER-FRIENDLY ADJUSTMENT & VERIFICATION

With the help of the unique "Soft Touch" instruments, the *proGAV*[®] 2.0 offers a high level of patient comfort with its tactile feedback.

Pressing the valve surface lightly with your finger releases the "Active-Lock" mechanism and simultaneously sends a tactile feedback.



MRI 3 TESLA CONDITIONAL

The "Active-Lock" mechanism of the *proGAV*[®] 2.0 prevents unintended valve adjustments by external magnetic fields up to 3 Tesla (3-5). Strainful follow-up examinations can thus be reduced for the patient.



GRAVITATIONAL TECHNOLOGY

Miethke gravitational valves offer a high protection against overdrainage complications in hydrocephalus therapy (6-8).



- (3) Allin DM, Czosnyka ZH, Czosnyka M, Richards HK, Pickard JD. In vitro hydrodynamic properties of the Miethke proGAV hydrocephalus shunt. *Cerebrospinal Fluid Res.* 2006 Jun;3:9.
- (4) Miyake H. Shunt Devices for the Treatment of Adult Hydrocephalus: Recent Progress and Characteristics. *Neurol Med Chir (Tokyo).* 2016 May 15;56(5):274–83.
- (5) Chari A, Czosnyka M, Richards HK, Pickard JD, Czosnyka ZH. Hydrocephalus shunt technology: 20 years of experience from the Cambridge Shunt Evaluation Laboratory. *J Neurosurg.* 2014 Mar;120(3):697–707.
- (6) Lemcke J, Meier U, Müller C, Fritsch MJ, Kehler U, Langer N, Kiefer M, Eymann R, Schuhmann MU, Speil A, Weber F, Remenez V, Rohde V, Ludwig HC, Stengel D. Safety and efficacy of gravitational shunt valves in patients with idiopathic normal pressure hydrocephalus: a pragmatic, randomised, open label, multicentre trial (SVASONA). *J Neurol Neurosurg Psychiatry.* 2013 Aug;84(8):850–7.
- (7) Freimann FB, Vajkoczy P, Sprung C. Patients benefit from low-pressure settings enabled by gravitational valves in normal pressure hydrocephalus. *Clin Neurol Neurosurg.* 2013 Oct;115(10):1982–6.
- (8) Suchorska B, Kunz M, Schniepp R, Jahn K, Goetz C, Tonn JC, Peraud A. Optimized surgical treatment for normal pressure hydrocephalus: comparison between gravitational and differential pressure valves. *Acta Neurochir (Wien).* 2015 Apr;157(4):703–9.

proGAV[®] 2.0

FUNCTIONALITY OF THE VALVE

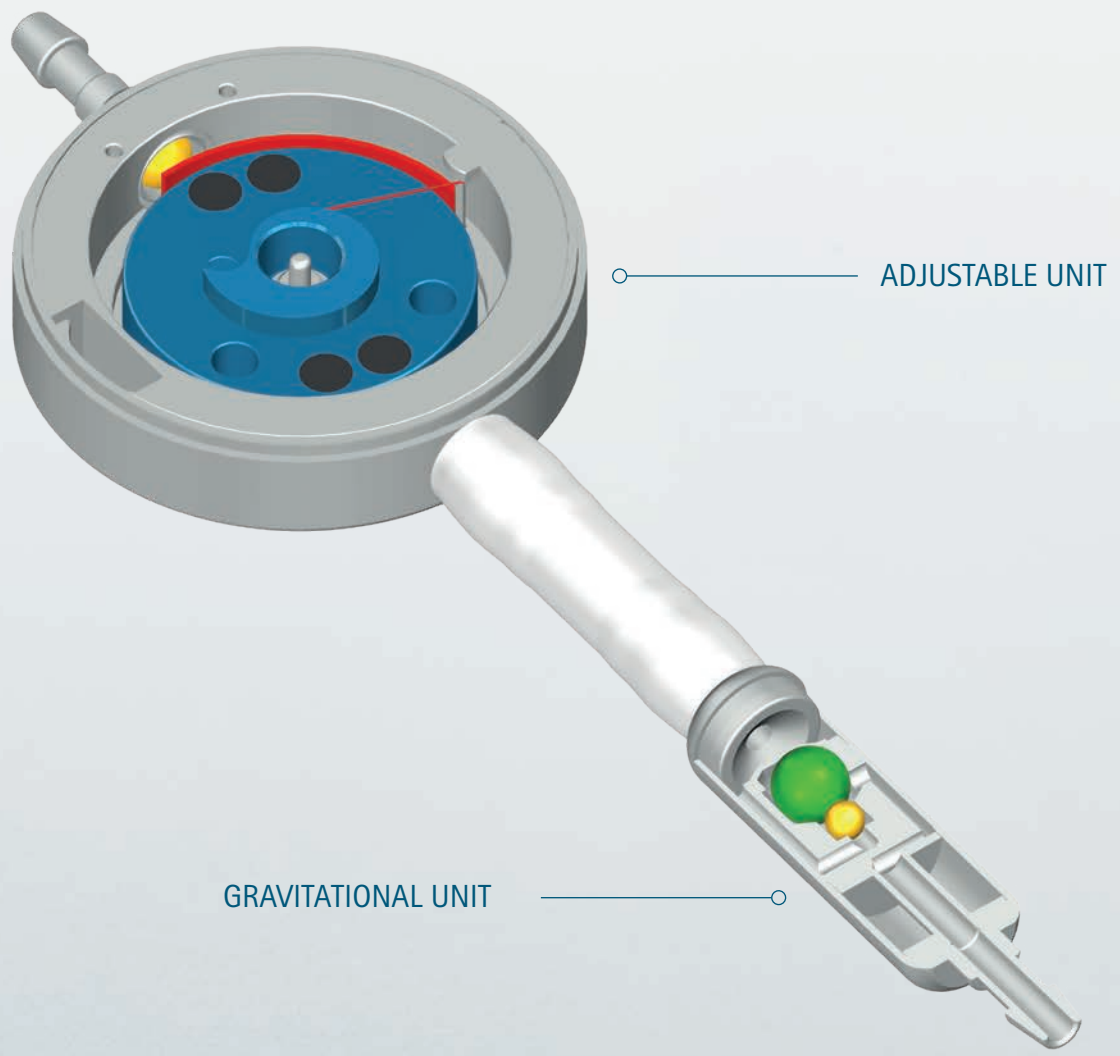

The adjustment unit is adjustable in 1 cmH₂O steps between 0 and 20 cmH₂O.

The gravitational unit is offered in different pressure levels.

The *proGAV*[®] 2.0 is a posture-dependent valve, meaning the opening pressure changes gradually to correspond with the patient's body position. *proGAV*[®] 2.0 allows for complete customization of the patient's needs a specific opening pressure when the patient is lying down and an opening pressure for when the patient is upright.

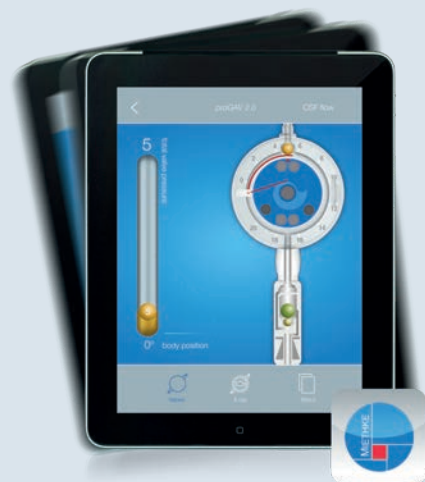

The functionality of *proGAV*[®] 2.0 in different body positions is illustrated interactively in the Miethke App.

proGAV[®] 2.0

FUNCTIONALITY OF VALVE AND BODY POSITION

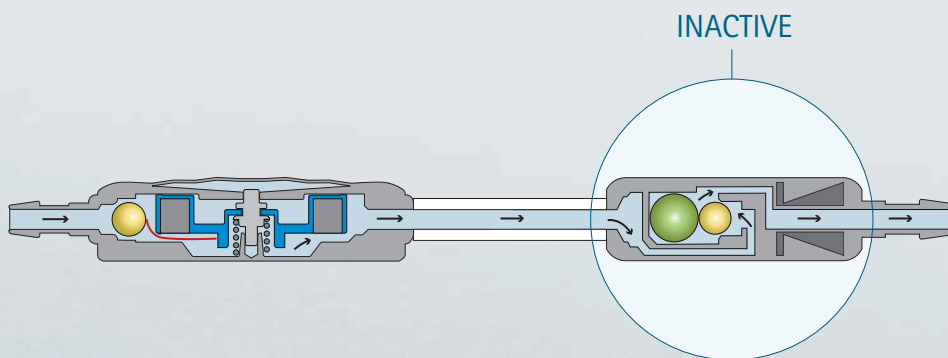
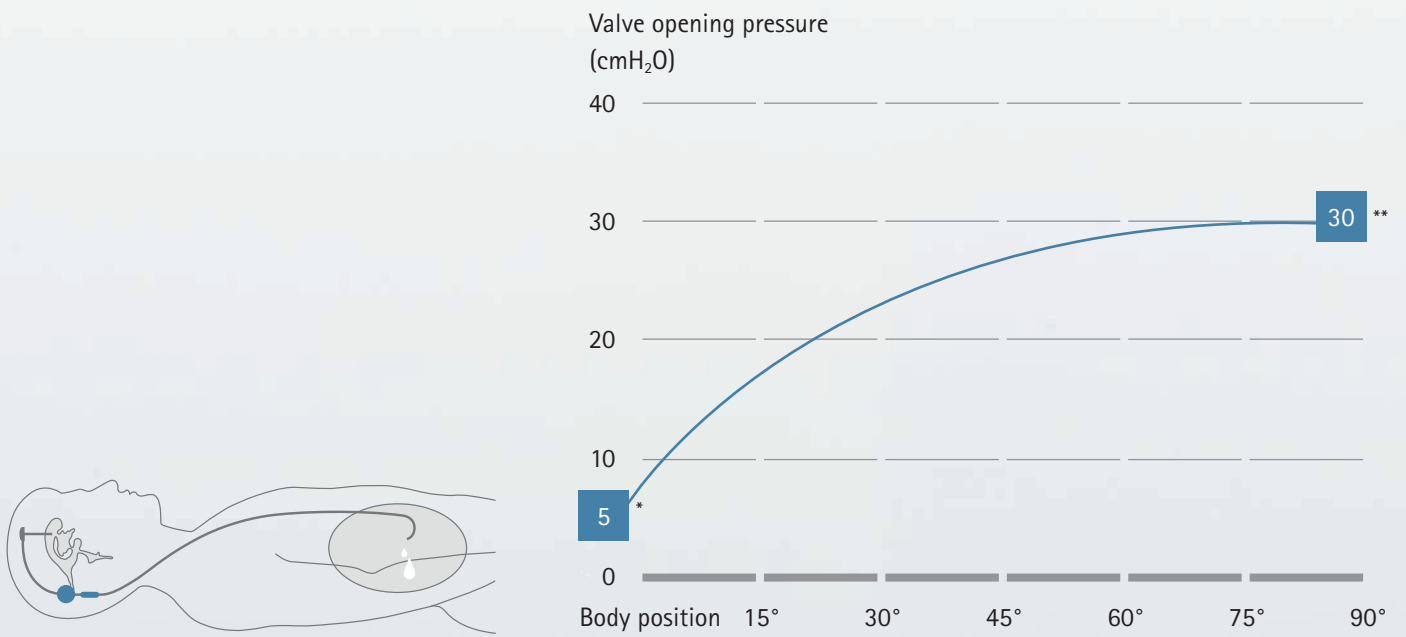

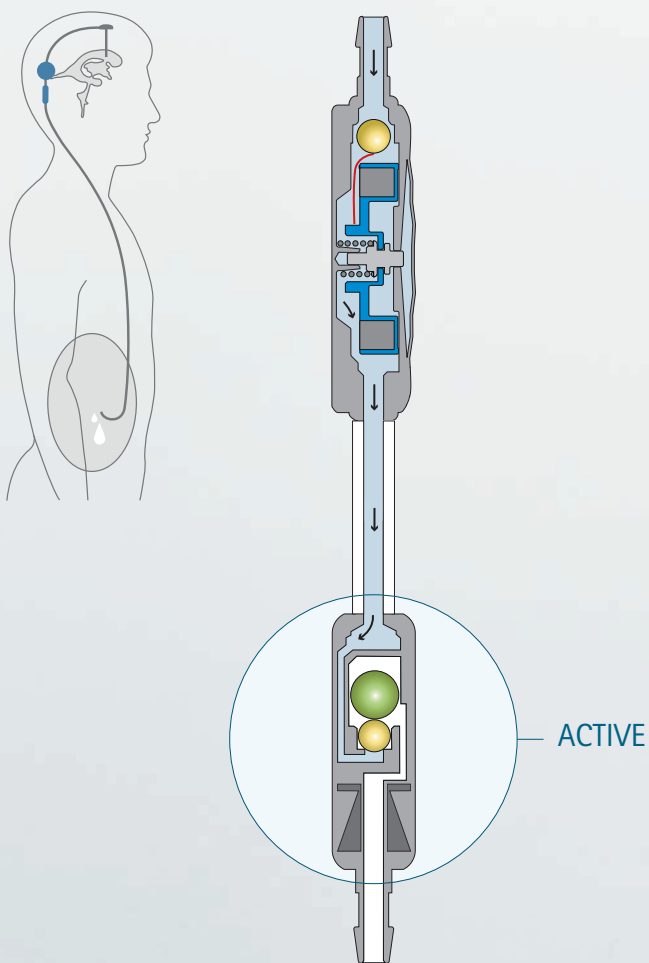

SUPINE POSITION

When the patient is in the supine position, only the adjustable unit is active and preset to 5 cmH₂O*.

The gravitational unit is not active in this body position.

UPRIGHT POSITION

In the upright position, the gravitational and adjustable unit work together. As the patient sits up, the tantalum ball (presented in green) is activated within the gravitational unit and due to its gravitational forces causes an increase in the valve opening pressure.

In the example shown, a gravitational unit with 25 cmH₂O has been selected. The total opening pressure therefore amounts to 30 cmH₂O** when standing.

proGAV[®] 2.0

SOFT TOUCH INSTRUMENTS FOR VALVE ADJUSTMENT

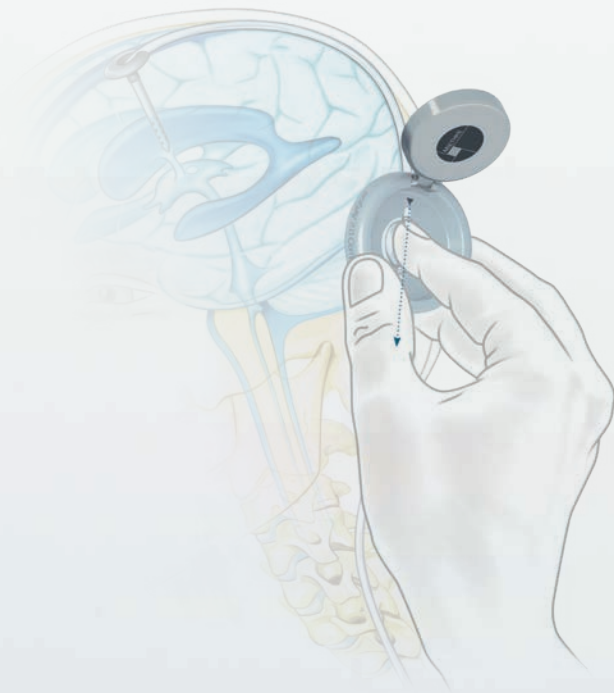

Fig. 1

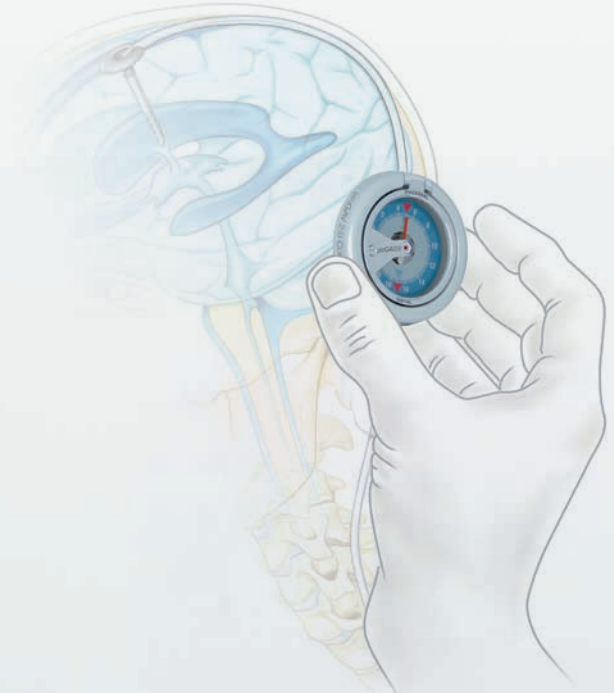

Fig. 2

LOCALIZATION AND SETTING IDENTIFICATION

The *proGAV*[®] 2.0 *Compass* is used to localize the adjustable unit and identify current setting of the valve.

The *Compass* should be aligned over the valve with the aid of the integrated template – *Compass* lid is open.

After the adjustable unit has been localized with the finger, the *proGAV*[®] 2.0 *Compass* is applied over the valve in the direction of flow (Fig. 1)

The closed *Compass* indicates the opening pressure setting (Fig. 2).

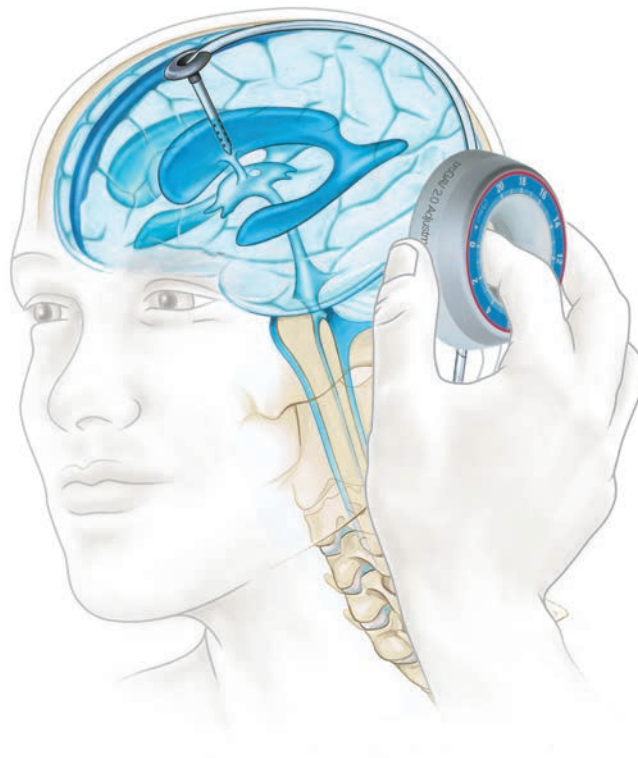

Fig. 3

ADJUSTING THE VALVE

The *proGAV® 2.0 Adjustment Tool* allows for an opening pressure of the adjustable unit to be set from 0 to 20 cmH₂O.









The *proGAV® 2.0 Adjustment Tool* should be positioned so that the desired opening pressure is reflected in the direction of the valve inlet connector.

The *proGAV® 2.0 Adjustment Tool* should be centered over the valve.

By pressing lightly with the finger on the adjustable unit, the mechanical "Active-Lock" mechanism is deactivated and the opening pressure is set. Releasing the finger pressure automatically locks the valve (Fig. 3).

proGAV[®] 2.0

PRESSURE RECOMMENDATION

Patient	Selection of pressure levels		Combined opening pressure	
	 Adjustable differential pressure unit	 Gravitational unit (SHUNTASSISTANT [®] 2.0)		
Newborn and children up to 5 years 	5	20	5	25
Children from 5 years 	10	25	10	35
Adults  < 1.60 m > 1.80 m	5	25	5	30
	5	20	5	25
	5	30	5	35
Adults from 65 years  < 1.60 m > 1.80 m	5	20	5	25
	5	15	5	20
	5	25	5	30

All pressure levels shown here are in cmH₂O. This is a non-binding recommendation. The physician decides in each case individually.

OPENING PRESSURE RECOMMENDATION

The choice of the appropriate pressure level of *proGAV*[®] 2.0 depends on several other factors, including age, degree of activity, size and stature of the patient. The values given apply

to mobile patients. For patients with little mobility or a high BMI, the gravitational unit should be chosen lower than recommended here.

proGAV[®] 2.0

WITH SA 2.0



- Combination of adjustable unit with gravitational unit



17 mm

12 mm

* Recommendations should only be used as guideline as other settings may also be necessary depending on the patient and anatomy.

Connector: $d_o = 1.9$ mm

Adjustable unit: $d_o = 4.5$ mm

Gravitational unit: $d_o = 4.2$ mm

Art. No.	Adjustable unit (5 cmH ₂ O presetting)	Gravitational unit
FX642T Children up to 5 years old and adults over 65*	0 - 20 cmH ₂ O	20 cmH ₂ O
FX643T Individuals between 5 and 65 years old*	0 - 20 cmH ₂ O	25 cmH ₂ O

OPTIONAL CONFIGURATIONS

Art. No.	Adjustable unit (5 cmH ₂ O presetting)	Gravitational unit
FX410T	0 - 20 cmH ₂ O	without
FX640T	0 - 20 cmH ₂ O	10 cmH ₂ O
FX641T	0 - 20 cmH ₂ O	15 cmH ₂ O
FX644T	0 - 20 cmH ₂ O	30 cmH ₂ O
FX645T	0 - 20 cmH ₂ O	35 cmH ₂ O

proGAV[®] 2.0

WITH SA 2.0 AND DISTAL CATHETER

- Combination of adjustable unit and gravitational unit with an integrated distal catheter (1200 mm)

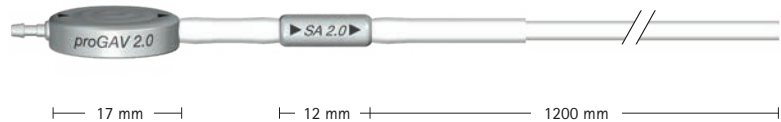

* Recommendations should only be used as guideline as other settings may also be necessary depending on the patient and anatomy.

Connector: $d_o = 1.9$ mm
 Adjustable unit: $d_o = 4.5$ mm
 Gravitational unit: $d_o = 4.2$ mm
 Catheter: $d_i = 1.2$ mm, $d_o = 2.5$ mm

Art. No.	Adjustable unit (5 cmH ₂ O presetting)	Gravitational unit
FX648T Children up to 5 years old and adults over 65*	0 - 20 cmH ₂ O	20 cmH ₂ O
FX649T Individuals between 5 and 65 years old*	0 - 20 cmH ₂ O	25 cmH ₂ O

OPTIONAL CONFIGURATIONS

Art. No.	Adjustable unit (5 cmH ₂ O presetting)	Gravitational unit
FX417T	0 - 20 cmH ₂ O	without
FX646T	0 - 20 cmH ₂ O	10 cmH ₂ O
FX647T	0 - 20 cmH ₂ O	15 cmH ₂ O
FX650T	0 - 20 cmH ₂ O	30 cmH ₂ O
FX651T	0 - 20 cmH ₂ O	35 cmH ₂ O

proGAV[®] 2.0

SHUNT SYSTEM WITH SA 2.0 AND PEDIATRIC SPRUNG RESERVOIR

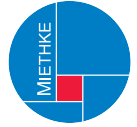

- Combination of adjustable unit and gravitational unit with an integrated distal catheter (1200 mm)
- Pediatric *SPRUNG RESERVOIR*** with an integrated distal catheter (200 mm)
- Ventricular catheter with introducing stylet (180 mm)

* Recommendations should only be used as guideline as other settings may also be necessary depending on the patient and anatomy.

** An additional valve in the base of the pediatric *SPRUNG RESERVOIR* makes it possible to flush the fluid only in the distal direction. This feature allows for controlling the patency of the ventricular catheter and the distal drainage.

Connector: $d_o = 1.9$ mm
 Adjustable unit: $d_o = 4.5$ mm
 Gravitational unit: $d_o = 4.2$ mm
 Catheter: $d_i = 1.2$ mm, $d_o = 2.5$ mm

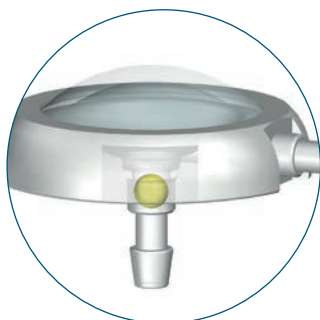
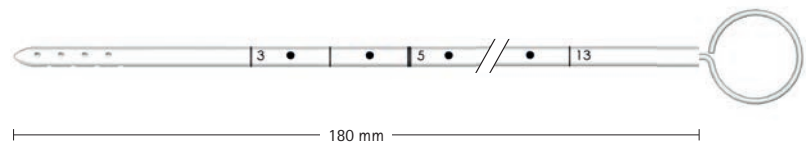
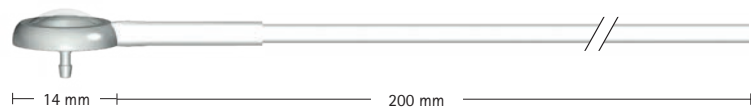
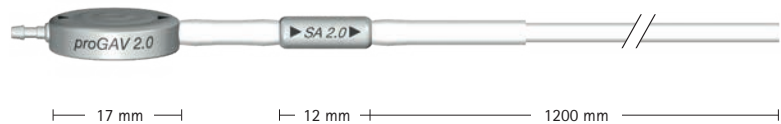

pediatric *SPRUNG RESERVOIR***

Art. No.	Adjustable unit (5 cmH ₂ O presetting)	Gravitational unit
FX583T Children up to 5 years old and adults over 65*	0 - 20 cmH ₂ O	20 cmH ₂ O
FX584T Individuals between 5 and 65 years old*	0 - 20 cmH ₂ O	25 cmH ₂ O

OPTIONAL CONFIGURATIONS

Art. No.	Adjustable unit (5 cmH ₂ O presetting)	Gravitational unit
FX580T	0 - 20 cmH ₂ O	without
FX581T	0 - 20 cmH ₂ O	10 cmH ₂ O
FX582T	0 - 20 cmH ₂ O	15 cmH ₂ O
FX585T	0 - 20 cmH ₂ O	30 cmH ₂ O
FX586T	0 - 20 cmH ₂ O	35 cmH ₂ O

proGAV[®] 2.0

SHUNT SYSTEM WITH SA 2.0 AND PEDIATRIC SPRUNG RESERVOIR

- Combination of adjustable unit with gravitational unit, pediatric *SPRUNG RESERVOIR*** with an integrated distal catheter (1200 mm)
- Ventricular catheter with introducing stylet (180 mm)

* Recommendations should only be used as guideline as other settings may also be necessary depending on the patient and anatomy.

** An additional valve in the base of the pediatric *SPRUNG RESERVOIR* makes it possible to flush the fluid only in the distal direction. This feature allows for controlling the patency of the ventricular catheter and the distal drainage.

Connector: $d_o = 1.9$ mm
 Adjustable unit: $d_o = 4.5$ mm
 Gravitational unit: $d_o = 4.2$ mm
 Catheter: $d_i = 1.2$ mm, $d_o = 2.5$ mm

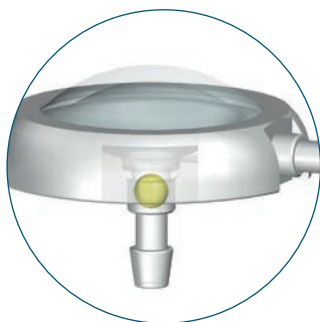
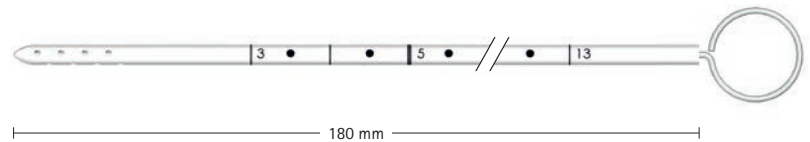
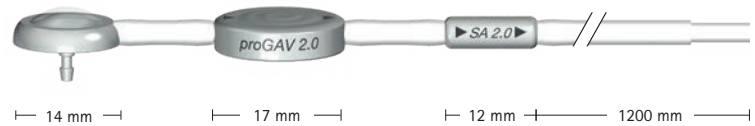

pediatric *SPRUNG RESERVOIR***

Art. No.	Adjustable unit (5 cmH ₂ O presetting)	Gravitational unit
FX636T Children up to 5 years old and adults over 65*	0 - 20 cmH ₂ O	20 cmH ₂ O
FX637T Individuals between 5 and 65 years old*	0 - 20 cmH ₂ O	25 cmH ₂ O

OPTIONAL CONFIGURATIONS

Art. No.	Adjustable unit (5 cmH ₂ O presetting)	Gravitational unit
FX633T	0 - 20 cmH ₂ O	without
FX634T	0 - 20 cmH ₂ O	10 cmH ₂ O
FX635T	0 - 20 cmH ₂ O	15 cmH ₂ O
FX638T	0 - 20 cmH ₂ O	30 cmH ₂ O
FX639T	0 - 20 cmH ₂ O	35 cmH ₂ O

proGAV[®] 2.0

SHUNT SYSTEM WITH SA 2.0 AND SPRUNG RESERVOIR



- Combination of adjustable unit with gravitational unit with an integrated distal catheter (1200 mm)
- *SPRUNG RESERVOIR*** with an integrated distal catheter (200 mm)
- Ventricular catheter with introducing stylet (180 mm)

* Recommendations should only be used as guideline as other settings may also be necessary depending on the patient and anatomy.

** An additional valve in the base of the *SPRUNG RESERVOIR* makes it possible to flush the fluid only in the distal direction. This feature allows for controlling the patency of the ventricular catheter and the distal drainage.

Connector: $d_o = 1.9$ mm
 Adjustable unit: $d_o = 4.5$ mm
 Gravitational unit: $d_o = 4.2$ mm
 Catheter: $d_i = 1.2$ mm, $d_o = 2.5$ mm

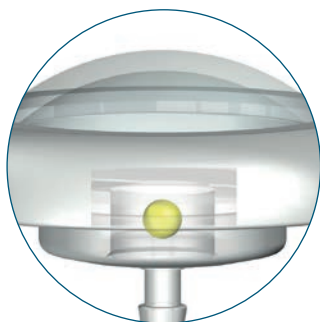
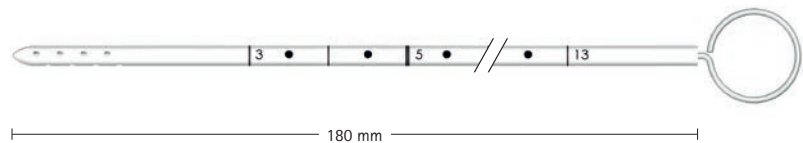
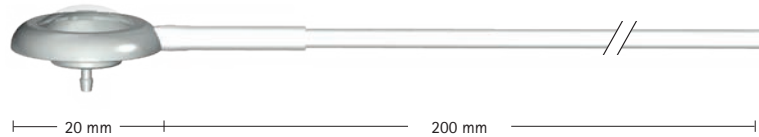
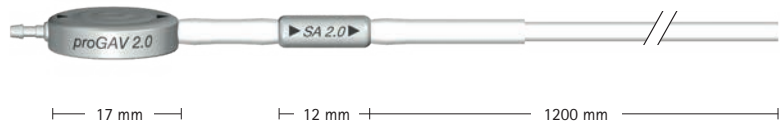

SPRUNG RESERVOIR**

Art. No.	Adjustable unit (5 cmH ₂ O presetting)	Gravitational unit
FX576T Children up to 5 years old and adults over 65*	0 - 20 cmH ₂ O	20 cmH ₂ O
FX577T Individuals between 5 and 65 years old*	0 - 20 cmH ₂ O	25 cmH ₂ O

OPTIONAL CONFIGURATIONS

Art. No.	Adjustable unit (5 cmH ₂ O presetting)	Gravitational unit
FX424T	0 - 20 cmH ₂ O	without
FX574T	0 - 20 cmH ₂ O	10 cmH ₂ O
FX575T	0 - 20 cmH ₂ O	15 cmH ₂ O
FX578T	0 - 20 cmH ₂ O	30 cmH ₂ O
FX579T	0 - 20 cmH ₂ O	35 cmH ₂ O

proGAV[®] 2.0

SHUNT SYSTEM WITH SA 2.0 AND SPRUNG RESERVOIR

- Combination of adjustable unit with gravitational unit, *SPRUNG RESERVOIR*** with an integrated distal catheter (1200 mm)
- Ventricular catheter with introducing stylet (180 mm)

* Recommendations should only be used as guideline as other settings may also be necessary depending on the patient and anatomy.

** An additional valve in the base of the *SPRUNG RESERVOIR* makes it possible to flush the fluid only in the distal direction. This feature allows for controlling the patency of the ventricular catheter and the distal drainage.

Connector: $d_o = 1.9$ mm
 Adjustable unit: $d_o = 4.5$ mm
 Gravitational unit: $d_o = 4.2$ mm
 Catheter: $d_i = 1.2$ mm, $d_o = 2.5$ mm

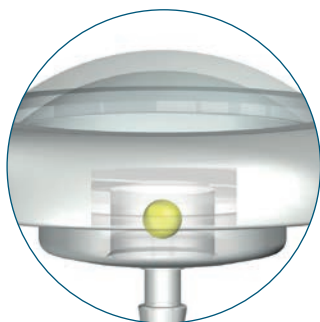
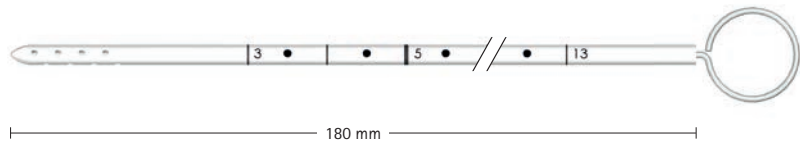
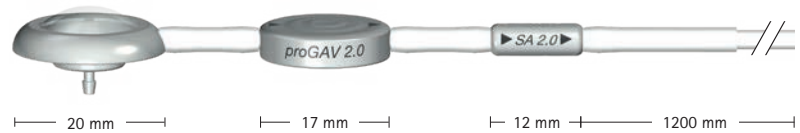

SPRUNG RESERVOIR**

Art. No.	Adjustable unit (5 cmH ₂ O presetting)	Gravitational unit
FX629T Children up to 5 years old and adults over 65*	0 - 20 cmH ₂ O	20 cmH ₂ O
FX630T Individuals between 5 and 65 years old*	0 - 20 cmH ₂ O	25 cmH ₂ O

OPTIONAL CONFIGURATIONS

Art. No.	Adjustable unit (5 cmH ₂ O presetting)	Gravitational unit
FX626T	0 - 20 cmH ₂ O	without
FX627T	0 - 20 cmH ₂ O	10 cmH ₂ O
FX628T	0 - 20 cmH ₂ O	15 cmH ₂ O
FX631T	0 - 20 cmH ₂ O	30 cmH ₂ O
FX632T	0 - 20 cmH ₂ O	35 cmH ₂ O

proGAV[®] 2.0

SHUNT SYSTEM WITH SA 2.0 AND PEDIATRIC CONTROL RESERVOIR



- Combination of adjustable unit with gravitational unit, pediatric *CONTROL RESERVOIR*** with an integrated distal catheter (1200 mm)
- Ventricular catheter with pediatric deflector and introducing stylet (250 mm)

* Recommendations should only be used as guideline as other settings may also be necessary depending on the patient and anatomy.

** An additional valve in the inlet of the pediatric *CONTROL RESERVOIR* makes it possible to flush the fluid only in the distal direction. This feature allows for controlling the patency of the ventricular catheter and the distal drainage.

Connector: $d_o = 1.9$ mm
 Adjustable unit: $d_o = 4.5$ mm
 Gravitational unit: $d_o = 4.2$ mm
 Catheter: $d_i = 1.2$ mm, $d_o = 2.5$ mm

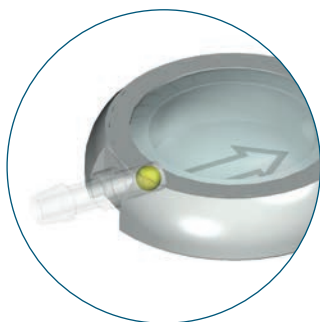
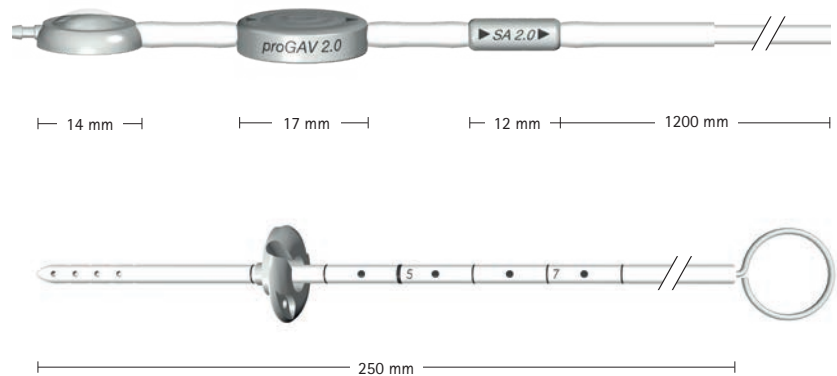

pediatric *CONTROL RESERVOIR***

Art. No.	Adjustable unit (5 cmH ₂ O presetting)	Gravitational unit
FX609T Children up to 5 years old and adults over 65*	0 - 20 cmH ₂ O	20 cmH ₂ O
FX610T Individuals between 5 and 65 years old*	0 - 20 cmH ₂ O	25 cmH ₂ O

OPTIONAL CONFIGURATIONS

Art. No.	Adjustable unit (5 cmH ₂ O presetting)	Gravitational unit
FX606T	0 - 20 cmH ₂ O	without
FX607T	0 - 20 cmH ₂ O	10 cmH ₂ O
FX608T	0 - 20 cmH ₂ O	15 cmH ₂ O
FX611T	0 - 20 cmH ₂ O	30 cmH ₂ O
FX612T	0 - 20 cmH ₂ O	35 cmH ₂ O

proGAV[®] 2.0

SHUNT SYSTEM WITH SA 2.0 AND PEDIATRIC CONTROL RESERVOIR

- Adjustable unit with pediatric *CONTROL RESERVOIR***
- Gravitational unit with integrated distal catheter (1200 mm)
- Ventricular catheter with pediatric deflector and introducing stylet (250 mm)

* Recommendations should only be used as guideline as other settings may also be necessary depending on the patient and anatomy.

** An additional valve in the inlet of the pediatric *CONTROL RESERVOIR* makes it possible to flush the fluid only in the distal direction. This feature allows for controlling the patency of the ventricular catheter and the distal drainage.

Connector: $d_o = 1.9$ mm
 Adjustable unit: $d_o = 4.5$ mm
 Gravitational unit: $d_o = 4.2$ mm
 Catheter: $d_i = 1.2$ mm, $d_o = 2.5$ mm



14 mm 17 mm



600 mm 12 mm 900 mm

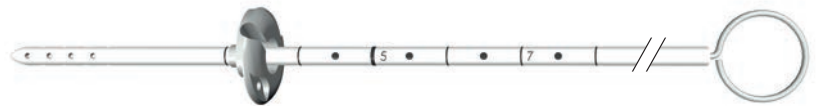

250 mm

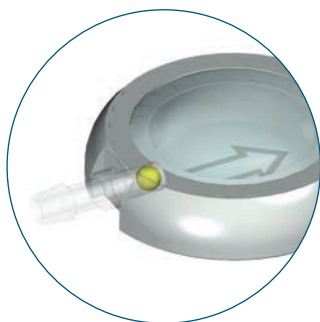

pediatric *CONTROL RESERVOIR***

Art. No.	Adjustable unit (5 cmH ₂ O presetting)	Gravitational unit
FX558T Children up to 5 years old and adults over 65*	0 - 20 cmH ₂ O	20 cmH ₂ O
FX559T Individuals between 5 and 65 years old*	0 - 20 cmH ₂ O	25 cmH ₂ O

OPTIONAL CONFIGURATIONS

Art. No.	Adjustable unit (5 cmH ₂ O presetting)	Gravitational unit
FX556T	0 - 20 cmH ₂ O	10 cmH ₂ O
FX557T	0 - 20 cmH ₂ O	15 cmH ₂ O
FX560T	0 - 20 cmH ₂ O	30 cmH ₂ O
FX561T	0 - 20 cmH ₂ O	35 cmH ₂ O

proGAV[®] 2.0

SHUNT SYSTEM WITH SA 2.0 AND CONTROL RESERVOIR

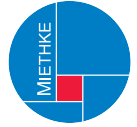

- Combination of adjustable unit and gravitational unit with *CONTROL RESERVOIR*** with an integrated distal catheter (1200 mm)
- Ventricular catheter with deflector and introducing stylet (250 mm)

* Recommendations should only be used as guideline as other settings may also be necessary depending on the patient and anatomy.

** An additional valve in the inlet of the *CONTROL RESERVOIR* makes it possible to flush the fluid only in the distal direction. This feature allows for controlling the patency of the ventricular catheter and the distal drainage.

Connector: $d_o = 1.9$ mm
 Adjustable unit: $d_o = 4.5$ mm
 Gravitational unit: $d_o = 4.2$ mm
 Catheter: $d_i = 1.2$ mm, $d_o = 2.5$ mm

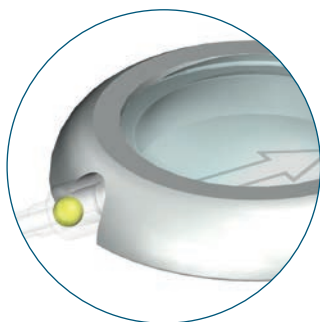
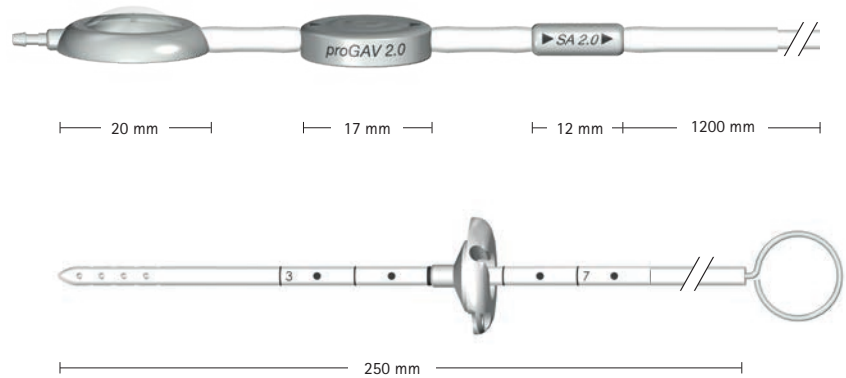

*CONTROL RESERVOIR***

Art. No.	Adjustable unit (5 cmH ₂ O presetting)	Gravitational unit
FX602T Children up to 5 years old and adults over 65*	0 - 20 cmH ₂ O	20 cmH ₂ O
FX603T Individuals between 5 and 65 years old*	0 - 20 cmH ₂ O	25 cmH ₂ O

OPTIONAL CONFIGURATIONS

Art. No.	Adjustable unit (5 cmH ₂ O presetting)	Gravitational unit
FX431T	0 - 20 cmH ₂ O	without
FX600T	0 - 20 cmH ₂ O	10 cmH ₂ O
FX601T	0 - 20 cmH ₂ O	15 cmH ₂ O
FX604T	0 - 20 cmH ₂ O	30 cmH ₂ O
FX605T	0 - 20 cmH ₂ O	35 cmH ₂ O

proGAV[®] 2.0

SHUNT SYSTEM MIT SA 2.0 AND CONTROL RESERVOIR

- Adjustable unit with integrated **CONTROL RESERVOIR****
- Gravitational unit with integrated proximal (600 mm) and distal catheter (900 mm)
- Ventricular catheter with deflector and introducing stylet (250 mm)

* Recommendations should only be used as guideline as other settings may also be necessary depending on the patient and anatomy.

** An additional valve in the inlet of the **CONTROL RESERVOIR** makes it possible to flush the fluid only in the distal direction. This feature allows for controlling the patency of the ventricular catheter and the distal drainage.

Connector: $d_o = 1.9$ mm
 Adjustable unit: $d_o = 4.5$ mm
 Gravitational unit: $d_o = 4.2$ mm
 Catheter: $d_i = 1.2$ mm, $d_o = 2.5$ mm



20 mm 17 mm



600 mm 12 mm 900 mm



250 mm

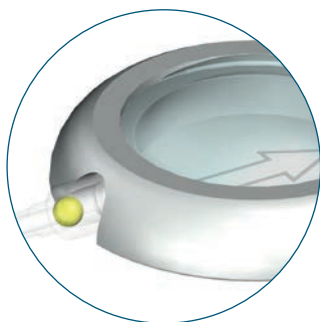

CONTROL RESERVOIR**

Art. No.	Adjustable unit (5 cmH ₂ O presetting)	Gravitational unit
FX551T Children up to 5 years old and adults over 65*	0 - 20 cmH ₂ O	20 cmH ₂ O
FX552T Individuals between 5 and 65 years old*	0 - 20 cmH ₂ O	25 cmH ₂ O

OPTIONAL CONFIGURATIONS

Art. No.	Adjustable unit (5 cmH ₂ O presetting)	Gravitational unit
FX549T	0 - 20 cmH ₂ O	10 cmH ₂ O
FX550T	0 - 20 cmH ₂ O	15 cmH ₂ O
FX553T	0 - 20 cmH ₂ O	30 cmH ₂ O
FX554T	0 - 20 cmH ₂ O	35 cmH ₂ O

- Combination of adjustable unit and gravitational unit with distal catheter (1200 mm)
- Pediatric burrhole reservoir with integrated distal catheter (200 mm)
- Ventricular catheter and introducing stylet (180 mm)

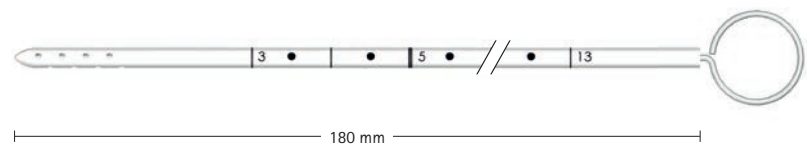
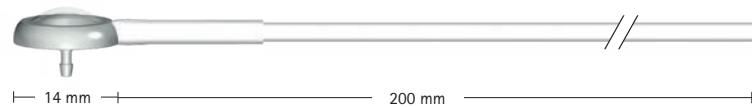
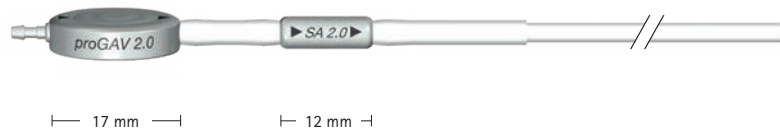

* Recommendations should only be used as guideline as other settings may also be necessary depending on the patient and anatomy.

Connector: $d_o = 1.9$ mm
 Adjustable unit: $d_o = 4.5$ mm
 Gravitational unit: $d_o = 4.2$ mm
 Catheter: $d_i = 1.2$ mm, $d_o = 2.5$ mm

Art. No.	Adjustable unit (5 cmH ₂ O presetting)	Gravitational unit
FX570T Children up to 5 years old and adults over 65*	0 - 20 cmH ₂ O	20 cmH ₂ O
FX571T Individuals between 5 and 65 years old*	0 - 20 cmH ₂ O	25 cmH ₂ O

OPTIONAL CONFIGURATIONS

Art. No.	Adjustable unit (5 cmH ₂ O presetting)	Gravitational unit
FX445T	0 - 20 cmH ₂ O	without
FX568T	0 - 20 cmH ₂ O	10 cmH ₂ O
FX569T	0 - 20 cmH ₂ O	15 cmH ₂ O
FX572T	0 - 20 cmH ₂ O	30 cmH ₂ O
FX573T	0 - 20 cmH ₂ O	35 cmH ₂ O

proGAV[®] 2.0

SHUNT SYSTEM WITH SA 2.0 AND PEDIATRIC BURRHOLE RESERVOIR

- Combination of adjustable unit with gravitational unit, pediatric burrhole reservoir with an integrated distal catheter (1200 mm)
- Ventricular catheter and introducing stylet (180 mm)

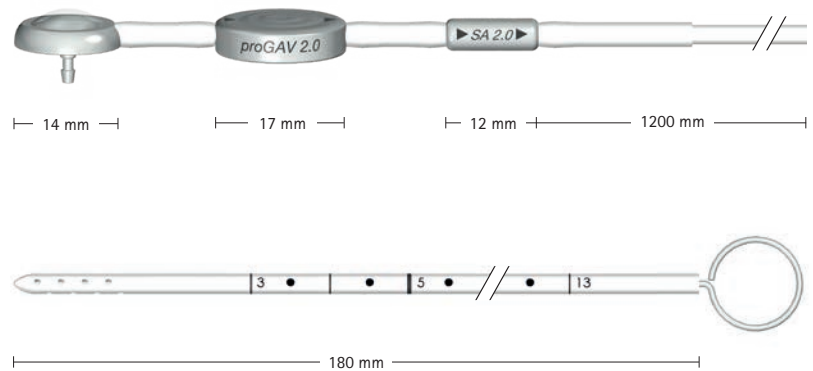

* Recommendations should only be used as guideline as other settings may also be necessary depending on the patient and anatomy.

Connector: $d_o = 1.9$ mm
 Adjustable unit: $d_o = 4.5$ mm
 Gravitational unit: $d_o = 4.2$ mm
 Catheter: $d_i = 1.2$ mm, $d_o = 2.5$ mm

Art. No.	Adjustable unit (5 cmH ₂ O presetting)	Gravitational unit
FX622T Children up to 5 years old and adults over 65*	0 - 20 cmH ₂ O	20 cmH ₂ O
FX623T Individuals between 5 and 65 years old*	0 - 20 cmH ₂ O	25 cmH ₂ O

OPTIONAL CONFIGURATIONS

Art. No.	Adjustable unit (5 cmH ₂ O presetting)	Gravitational unit
FX468T	0 - 20 cmH ₂ O	without
FX620T	0 - 20 cmH ₂ O	10 cmH ₂ O
FX621T	0 - 20 cmH ₂ O	15 cmH ₂ O
FX624T	0 - 20 cmH ₂ O	30 cmH ₂ O
FX625T	0 - 20 cmH ₂ O	35 cmH ₂ O

proGAV[®] 2.0

SHUNT SYSTEM WITH SA 2.0 AND PEDIATRIC PRECHAMBER



- Combination of adjustable unit with gravitational unit, pediatric prechamber with an integrated distal catheter (1200 mm)
- Ventricular catheter with pediatric deflector and introducing stylet (250 mm)

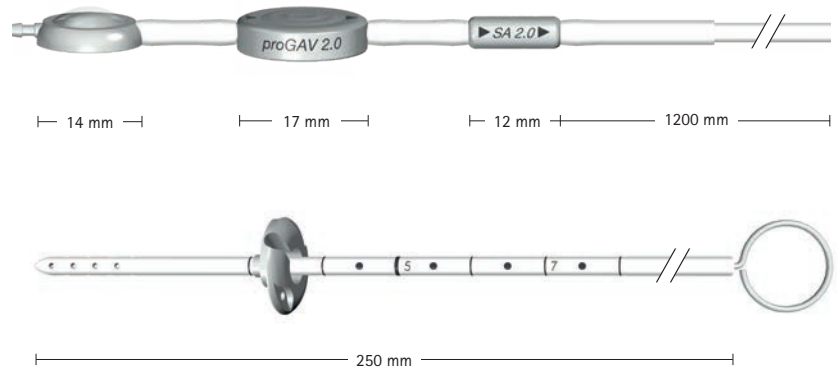

* Recommendations should only be used as guideline as other settings may also be necessary depending on the patient and anatomy.

Connector: $d_o = 1.9$ mm
 Adjustable unit: $d_o = 4.5$ mm
 Gravitational unit: $d_o = 4.2$ mm
 Catheter: $d_i = 1.2$ mm, $d_o = 2.5$ mm

Art. No.	Adjustable unit (5 cmH ₂ O presetting)	Gravitational unit
FX596T Children up to 5 years old and adults over 65*	0 - 20 cmH ₂ O	20 cmH ₂ O
FX597T Individuals between 5 and 65 years old*	0 - 20 cmH ₂ O	25 cmH ₂ O

OPTIONAL CONFIGURATIONS

Art. No.	Adjustable unit (5 cmH ₂ O presetting)	Gravitational unit
FX438T	0 - 20 cmH ₂ O	without
FX594T	0 - 20 cmH ₂ O	10 cmH ₂ O
FX595T	0 - 20 cmH ₂ O	15 cmH ₂ O
FX598T	0 - 20 cmH ₂ O	30 cmH ₂ O
FX599T	0 - 20 cmH ₂ O	35 cmH ₂ O

proGAV[®] 2.0

SHUNT SYSTEM WITH SA 2.0 AND PRECHAMBER

- Adjustable unit with prechamber
- Gravitational unit with integrated proximal (600 mm) and distal catheter (900 mm)
- Ventricular catheter with deflector and introducing stylet (250 mm)

* Recommendations should only be used as guideline as other settings may also be necessary depending on the patient and anatomy.

Connector: $d_o = 1.9$ mm
 Adjustable unit: $d_o = 4.5$ mm
 Gravitational unit: $d_o = 4.2$ mm
 Catheter: $d_i = 1.2$ mm, $d_o = 2.5$ mm

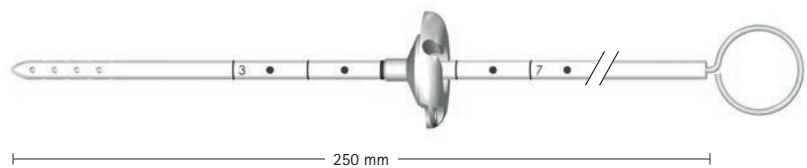
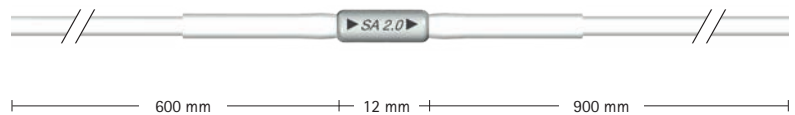
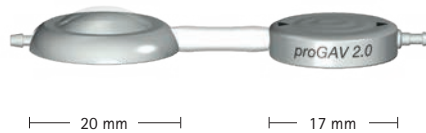

Art. No.	Adjustable unit (5 cmH ₂ O presetting)	Gravitational unit
FX539T Children up to 5 years old and adults over 65*	0 - 20 cmH ₂ O	20 cmH ₂ O
FX540T Individuals between 5 and 65 years old*	0 - 20 cmH ₂ O	25 cmH ₂ O

OPTIONAL CONFIGURATIONS

Art. No.	Adjustable unit (5 cmH ₂ O presetting)	Gravitational unit
FX537T	0 - 20 cmH ₂ O	10 cmH ₂ O
FX538T	0 - 20 cmH ₂ O	15 cmH ₂ O
FX541T	0 - 20 cmH ₂ O	30 cmH ₂ O
FX542T	0 - 20 cmH ₂ O	35 cmH ₂ O

proGAV[®] 2.0

TOOLS

- *proGAV[®] 2.0 Adjustment Tool*
- *proGAV[®] 2.0 Compass*
- *proGAV[®] 2.0 Tool Set*
- *proGAV[®] Check-mate, re-sterilisable*



proGAV[®] 2.0 Adjustment Tool



proGAV[®] 2.0 Compass



proGAV[®] 2.0 Tool Set



proGAV[®] Check-mate

Art. No.	Tools
FX400T	<i>proGAV[®] 2.0 Adjustment Tool</i>
FX401T	<i>proGAV[®] 2.0 Compass</i>
FX404T	<i>proGAV[®] 2.0 Tool Set</i> (contains FX400T and FX401T)
FV409T	<i>proGAV[®] Check-mate, re-sterilisable</i>
on request	<i>proGAV[®] 2.0 X-ray template and</i> <i>pressure recommendation card</i>

- *proSA[®] Adjustment Tool*
- *proSA[®] Verification Tool*



proSA[®] Adjustment Tool



proSA[®] Verification Tool

Art. No.	Tools
FV790T	<i>proSA[®] Adjustment Tool</i>
FV791T	<i>proSA[®] Verification Tool</i>

- *proSA® Tool Set*
- *proSA® Masterdisc*
- *proSA® Compass*
- *proSA® Adjustment Disc*
- *proSA® Check-mate, re-sterilisable*



proSA® Tool Set



proSA® Masterdisc



proSA® Compass



proSA® Adjustment Disc



proSA® Check-mate

Art. No.	Instruments
FV792T	<i>proSA® Tool Set</i> (contains FV790T - FV791T, FV793T - FV795T)
FV793T	<i>proSA® Masterdisc</i>
FV794T	<i>proSA® Compass</i>
FV795T	<i>proSA® Adjustment Disc</i>
FV796T	<i>proSA® Check-mate, re-sterilisable</i>
on request	<i>proSA® X-ray template and pressure recommendation card</i>









NEUROSURGERY

WE UNDERSTAND THE GRAVITY OF THE SITUATION.

GRAVITATIONAL VALVES BY MIETHKE

AESCLAP® – a B. Braun brand

OUR SHUNT SYSTEMS – YOUR CHOICE

<i>proSA®</i>	<i>proGAV® 2.0</i>	<i>GAV® 2.0</i>	<i>SHUNT-ASSISTANT® 2.0 Valve</i>	<i>DUALSWITCH Valve</i>	<i>miniNAV®</i>	<i>Accessories</i>
						

Description	
Adjustable gravitational unit with differential pressure valve	Adjustable differential pressure valve with gravitational unit
Gravitational valve for the treatment of hydrocephalus	Gravitational valve for integration into shunt systems in order to avoid excess drainage
Gravitational valve with large flow volumes for CSF	Differential pressure valve, specifically for premature babies and newborns or bedridden or non-mobile patients

Indication	
LP	✓
NPH	✓
Pediatric HC	✓
Adult HC	✓
Patient	
Lying	✓
Active	✓*

Feature	
3-Tesla MR Conditional	✓
Gravitational unit	✓
Adjustable	✓

* in combination with SHUNTASSISTANT® 2.0 or proSA®



SENSOR RESERVOIR

SENSOR PRECHAMBER

TELEMETRIC SHUNT CONTROL – READING INNER VALUES

AESCLAP® – a B. Braun brand

Aesculap AG | Am Aesculap-Platz | 78532 Tuttlingen | Germany | www.aesculap.com

Manufacturer acc. to MDD 93/42/EEC

■ **CHRISTOPH MIETHKE GMBH & CO. KG**

Christoph Miethke GmbH & Co. KG | Ulanenweg 2 | 14469 Potsdam | Germany
Phone +49 331 62083-0 | Fax +49 331 62083-40 | www.miethke.com

AESCULAP[®] – a B. Braun brand

Distributed by

Aesculap AG | Am Aesculap-Platz | 78532 Tuttlingen | Germany
Phone +49 7461 95-0 | Fax +49 7461 95-2600 | www.aesculap.com

The product trademarks "GAV", "miniNAV", "proGAV", "proSA" and "SHUNTASSISTANT" are registered trademarks of Christoph Miethke GmbH & Co. KG in the majority of the world. For more detailed information please contact us: info@miethke.com. The main product trademark "Aesculap" is a registered trademark of Aesculap AG.

Subject to technical changes. All rights reserved. This brochure may only be used for the exclusive purpose of obtaining information about our products. Reproduction in any form partial or otherwise is not permitted.