

Aesculap® Heart XS Retraction System

for Median Sternotomy

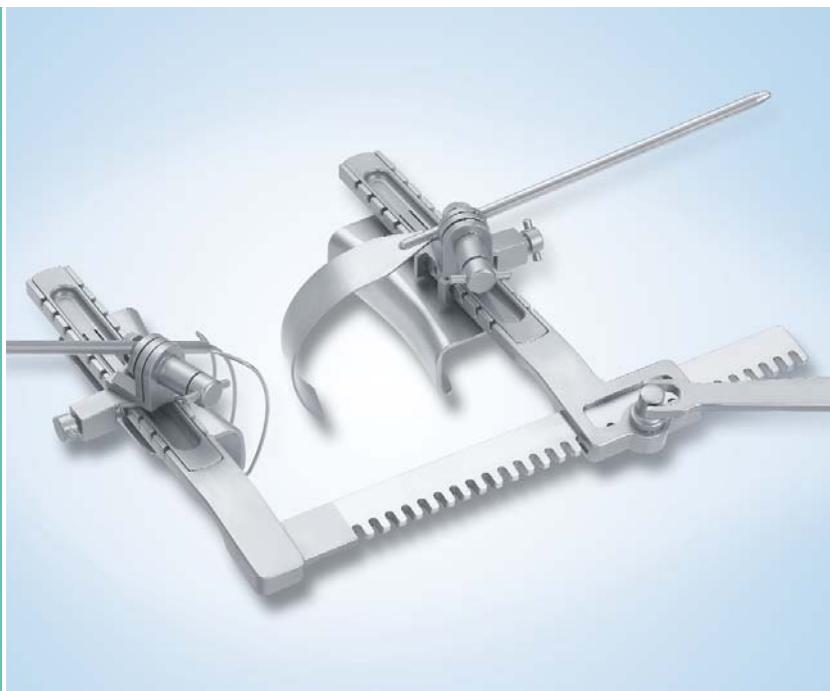

Aesculap Surgical Technologies

Aesculap® Heart XS Retraction System

for Median Sternotomy

Retractor only
Retraktor allein

FC137R

Heart XS Retractor only, for Median Sternotomy
Heart XS Retraktor allein, für die mediane Sternotomie

Ratchet bar Zahnstange	Arm length Armlänge	Max. opening Max. Öffnungsweite
280 mm	225 mm	200 mm

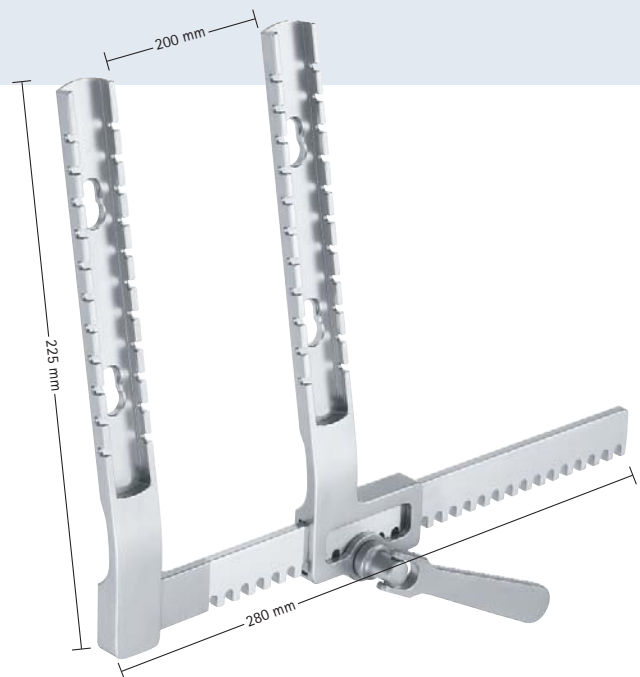

1/3

Interchangeable Blades, quantity unit: piece
Auswechselbare Blätter, Mengeneinheit: Stück



FC131R

40 x 100 mm
Heart XS Fixed Blades
Heart XS feststehende Blätter



FC132R

30 x 100 mm
Heart XS Fixed Blades
Heart XS feststehende Blätter



FC136R

Heart XS Insert Blank 160 mm for blade fixation. Locks blades securely in the retractor.

Heart XS Fixiereinsatz 160 mm. Arretiert die Blätter fest und sicher am Retraktor.

1/2



FC133R

43 x 28 mm
Heart XS Swiveling Blades
Heart XS drehbare Blätter



FC134R

33 x 28 mm
Heart XS Swiveling Blades
Heart XS drehbare Blätter

Fits to the individual patient anatomy of the sternum bone.
Passt sich der individuellen Anatomie des Sternums an.

Basic Set
Basis Set

FC120R

Heart XS Retraction System for Median Sternotomy.

Set consisting of:

- 1x FC137R – Heart XS Retractor only
- 2x FC132R – 30 x 100 mm Fixed Blade
- 2x FC136R – Insert Blank

Heart XS Retraktionssystem für die mediane Sternotomie.

Set bestehend aus:

- 1x FC137R – Heart XS Retraktor allein
- 2x FC132R – 30 x 100 mm feststehendes Blatt
- 2x FC136R – Fixiereinsatz



1/3

Optional Accessories
Optionales Zubehör

Heart XS Cooley Atrium Retractor
Heart XS Cooley Atrium Retraktor

Art.-No. Art.-Nr.	Depth Tiefe	Width Breite	Total length Gesamtlänge	Shaft Schaft
FC125R	60 mm	20 mm	250 mm	rigid/starr
FC126R	60 mm	35 mm	250 mm	rigid/starr
FC127R	60 mm	45 mm	250 mm	rigid/starr

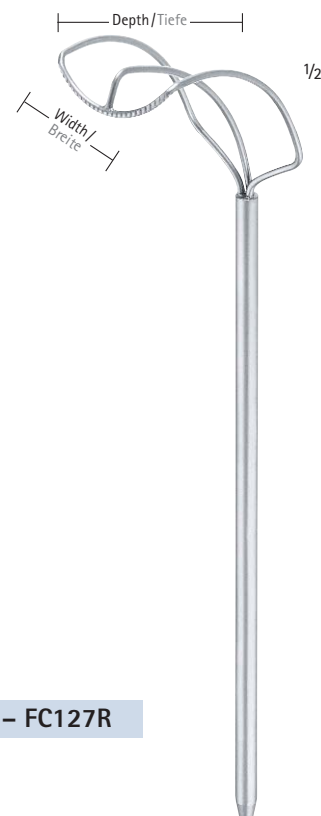

FC125R – FC127R
rigid / starr

Configuration Sample
Konfigurationsbeispiel

- 1x FC137R – Heart XS Retractor
- 2x FC132R – 30 x 100 mm Fixed Blade
- 2x FC136R – Insert Blank
- 2x FC138R – Connecting Clamp for Accessories
- 1x FC124R – Deaver Valve Hook
- 1x FC126R – COOLEY Atrium Retractor
- 1x FC137R – Heart XS Retractor
- 2x FC132R – 30 x 100 mm feststehendes Blatt
- 2x FC136R – Fixiereinsatz
- 2x FC138R – Fixierklemme für Zubehör
- 1x FC124R – Deaver Klappenhaken
- 1x FC126R – COOLEY Atrium Retraktor

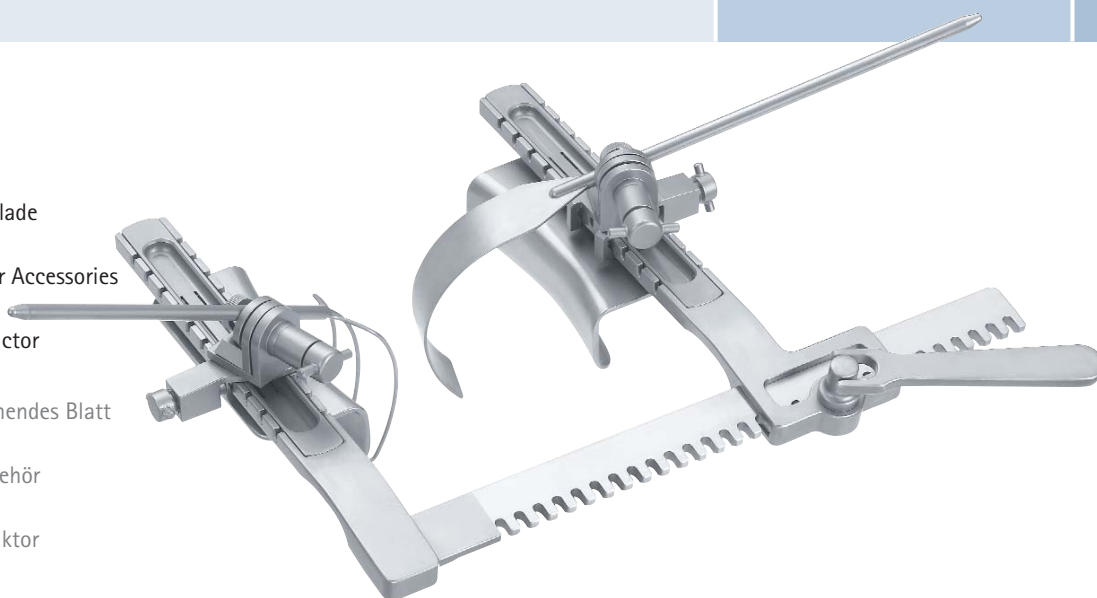

1/2

Optional Accessories
Optionales Zubehör

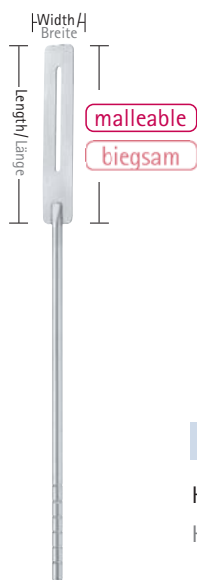

FC121R – FC123R

Heart XS Malleable Valve Hook
Heart XS biegsamer Klappenhaken

Art.-No. Art.-Nr.	Length Länge	Width Breite	Total length Gesamtlänge
FC121R	65 mm	18 mm	250 mm
FC122R	95 mm	18 mm	280 mm
FC123R	95 mm	22 mm	280 mm



FC124R

Heart XS Malleable Deaver Valve Hook
Heart XS biegsamer Deaver Klappenhaken

Art.-No. Art.-Nr.	Length Länge	Width Breite	Total length Gesamtlänge
FC124R	75 mm	25 mm	250 mm



FC138R

Heart XS Connecting Clamp for optional Accessories
Heart XS Fixierklemme für optionales Zubehör

1/4

Aesculap® Heart XS Retraction System

for Median Sternotomy



1/3

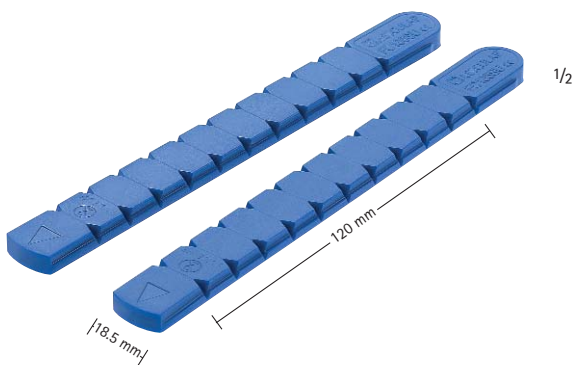
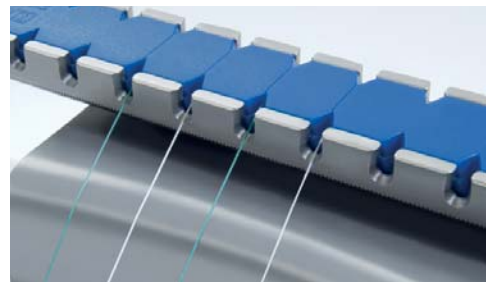

1/2

FC135SU

Heart XS Single Use Insert Blank for suture fixation
Heart XS Fixier- und Fadenhalterung zum Einmalgebrauch

Art.-No. Art.-Nr.	Length Länge	Width Breite	Total length Gesamtlänge
FC135SU	120 mm	18.5 mm	170 mm



1 box FC135SU contains 10 packs of 2 suture fixations
1 Box FC135SU enthält 10 Packungen à 2 Fadenhalterungen

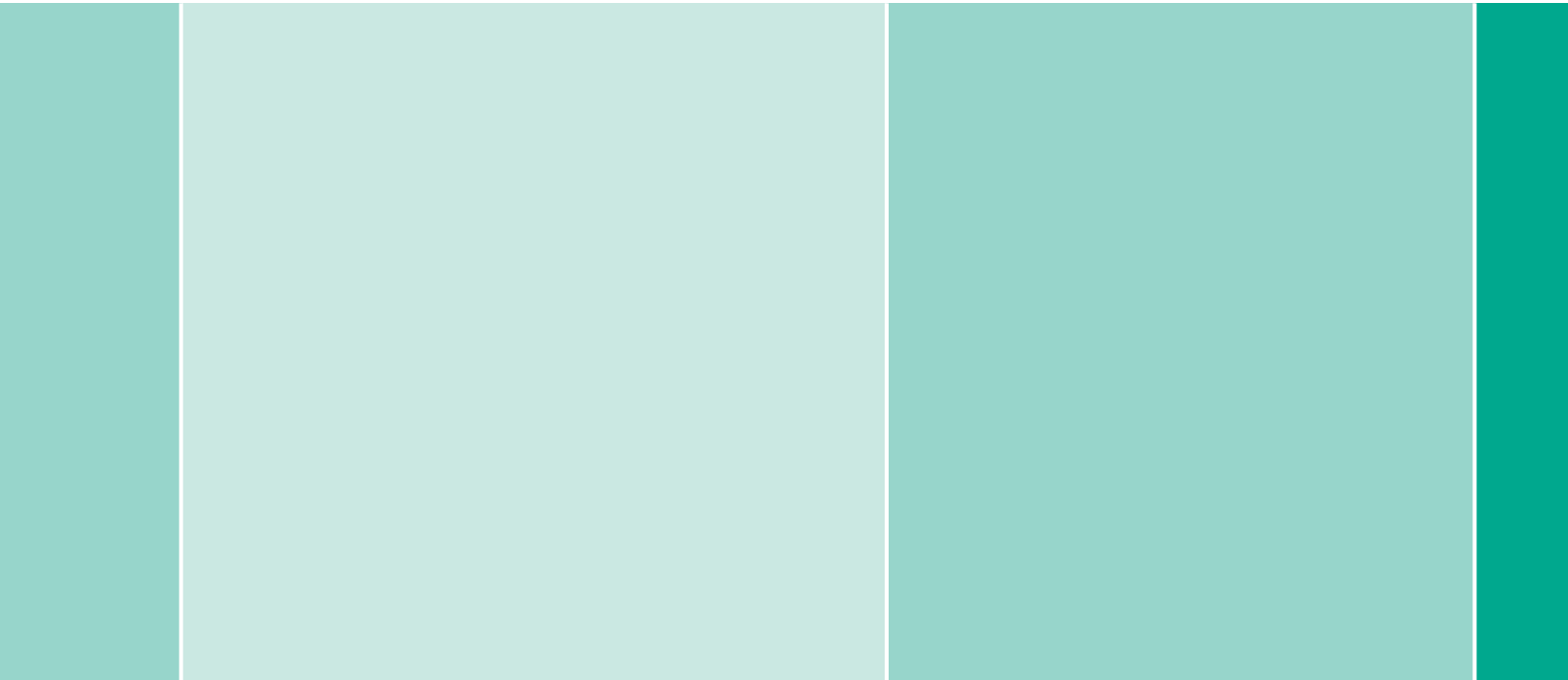

The main product trademark 'Aesculap' is a registered trademark of Aesculap AG.

Subject to technical changes. All rights reserved. This brochure may only be used for the exclusive purpose of obtaining information about our products. Reproduction in any form partial or otherwise is not permitted.

Aesculap AG | Am Aesculap-Platz | 78532 Tuttlingen | Germany
Phone +49 (0) 74 61 95-0 | Fax +49 (0) 74 61 95-26 00 | www.aesculap.com

Aesculap – a B. Braun company

Brochure No. C63911

0612/1.0/2